



Rose Kennedy Greenway Conservancy

2025-2027 Masonry Contract RFP

Response Deadline: **2/7/25**

Table of Contents

I. Project Description

II. Project Scope

III. RFP Schedule

3.1 RFP Contact

IV. Submission Instructions

4.1 Written Proposal

4.2 Fee Proposal

4.3 Insurance

4.3 Submission

V. Evaluation Process

5.1 Evaluation Criteria

5.2 Contract Award

5.3 Board Approval

VI. Terms and Conditions

6.1 Procurement Amendments

6.2 Project Budget and Subdivision of Contract

6.3 Procurement Cancellation

6.4 Corrections to a Submitted Response

6.5 References

6.6 Disqualification

6.7 Disclosure

6.8 Contract and Amendment Negotiation

6.9 Conflict of Interest

EXHIBIT A - Fee Proposal

EXHIBIT B - Description of Area to be Serviced

EXHIBIT C - Park Use Guidelines

EXHIBIT D - Skate Stop Styles

I. PROJECT DESCRIPTION

The Rose Kennedy Greenway Conservancy (“Conservancy”) is seeking a masonry contractor to furnish all labor, materials and equipment necessary to complete masonry repairs and enhancements on the Greenway over the course of a 3 year term (March 28, 2025-December 31, 2027). The Contractor would perform a variety of masonry services throughout The Greenway, listed below in the Project Scope.

The Greenway consists of an array of masonry materials, varying in the type and frequency of upkeep they require. These plazas, walkways, vertical structures, and paths are heavily trafficked and require ongoing maintenance. The masonry contractor will perform masonry repairs and restoration at least twice annually, as prioritized by the Greenway Conservancy Maintenance staff and in accordance with the unit pricing submitted in response to this RFP. The Conservancy would expect the selected contractor to be available to complete masonry work on the Greenway between approximately March 15-May 31st and September 15-November 30 each year of the contract term.

Over the three year term, the Conservancy currently has approximately \$450,000 budgeted for masonry work throughout the park. See Exhibit B for a map of The Greenway. **RFP Submittals are due by 2/7/25..**

The Conservancy anticipates certain specialty masonry projects, above and beyond the base contract, may occasionally arise. In that event, the Conservancy reserves the right to publicly procure these projects and may ask the Contractor to submit a competitive bid for those projects.

II. PROJECT SCOPE

The scope of this project is maintenance, repairs, enhancements and replacements of the Greenways' various hardscape elements. These include, but are not limited to, granite paving, granite curbs, concrete unit pavers, fan pavers, vertical granite veneer, stairs, concrete sidewalks, brick pavers, etc. Please see Exhibit A for a complete list.

Masonry services that typically need to be performed on The Greenway include, repointing of mortar joints, re-caulking of expansion joints, removal and replacement of granite pavers, removal and resetting of granite pavers, removal and resetting or replacement of granite veneer, patching/repairing granite, skate deterrent installation, unit pavers installation, removal and resetting of unit and fan pavers, repair, removal and replacement of concrete sidewalks.

The contractor shall procure all required permits and licenses except as otherwise specified herein. The contractor shall comply with all laws and other requirements of regulatory authority, shall pay all charges fees and taxes (where applicable) and shall give all notices necessary and incidental to the due and lawful prosecution of the work.

III. RFP SCHEDULE

Phase	Date
RFP released	January 14
Site visit (optional)	January 20, 10am
Any questions due via email	January 24, 5pm
Answers to RFP questions posted on the Greenway's website	January 31, 5pm
Deadline for proposals	February 7, 5pm
Contractor team interviews	February 17 - 28
Contractor team selected	March 7
Contract start	March 28

*For the site visit, please RSVP via email to rtzen@rosekennedygreenway.org. We will meet in Chinatown Park under the traditional gate over Beach Street on **Monday, January 20 at 10am**, weather dependent.

3.1 RFP CONTACT

Once the RFP has been released, all communications by responding parties should be directed in writing via email to:

Rex Tzen
Capital Projects Manager
Email: rtzen@rosekennedygreenway.org

Any oral communication is considered unofficial and non-binding to the Conservancy. After the proposal deadline, vendors should not contact the RFP contact or any other member of the Conservancy on matters related to the procurement, except to respond to a request by the RFP contact.

Please note that the Conservancy is subject to the Massachusetts Public Records Law (M.G.L. ch. 66, Sec. 10), and will comply with any requests for information relating to this procurement process to the extent required by law.

IV. SUBMISSION INSTRUCTIONS

4.1 WRITTEN PROPOSAL

A) Response to Scope of Services

RFP proposals should outline unit pricing for all items listed in the Fee Proposal (Exhibit A.)

B) Experience and Qualifications

Include examples of comparable projects and clients in regard to scope, scale or setting.

C) Firm Description, Staffing Plan, and Key Staff Qualifications

Describe the qualifications and experience of the project manager, key support staff and any anticipated subcontractors to be assigned to the project.

The Conservancy takes pride in the diversity of its workforce and contractors. Please identify if your company is a Small, Small Local, Minority, or Women Business Enterprise. Please also identify diversity within your workforce and specifically within the team that will work on the Greenway.

D) References

Provide contact information for three references of clients and/or organizations that can attest to your ability to successfully complete a project of comparable magnitude and complexity. References should have had firsthand work experience with your company within the past 10 years.

4.2 FEE PROPOSAL

Please use the fee proposal form provided (Exhibit A) to outline anticipated fees. Contractor shall outline any anticipated annual escalators in their proposal.

4.3 INSURANCE

The following insurance requirements represent the minimum required insurance coverages and limits that the Contractor will need to provide, as further detailed in the contract. It is understood that these limits will not limit the liability of the Contractor.

A. Workers Compensation

Contractor shall maintain the following workers compensation limits:

Coverage A Workers Compensation: Statutory as Required by Massachusetts Law

Coverage B Employers Liability:

- bodily injury by accident \$500,000 each accident
- bodily injury by disease \$500,000 each employee
- bodily injury by disease \$500,000 policy limit

B. Property

Contractor must secure property insurance on an all risk basis, subject to full replacement cost for all property used in conjunction with Contractor's operations with the Conservancy. Such insurance should contain a waiver of subrogation stating Contractor waives all rights of subrogation against the Conservancy for loss to Contractor's property. It is agreed that the Conservancy is not responsible for any loss whatsoever to Contractor's property.

C. Automobile Liability

Contractor shall maintain the following minimum limits of automobile liability insurance:

- \$1,000,000 per accident, bodily injury and property damage combined
- Coverage must include non-owned and hired liability.

D. General Liability

Contractor shall maintain the following minimum limits of general liability insurance:

- \$1,000,000 per occurrence for bodily injury and property damage
- \$5,000 medical expense
- \$1,000,000 personal injury
- \$2,000,000 general aggregate
- \$1,000,000 products / completed operations

Coverage must be equivalent to the most recent edition of ISO Form CG 01 01.

Coverage must be provided on a first dollar basis without a deductible. General liability policies subject to a deductible will need to be approved by the Conservancy.

E. Umbrella

Contractor shall maintain the following umbrella limits:

- \$5,000,000 per occurrence
- \$5,000,000 aggregate

Self Insured Retention: Not to exceed \$10,000.

Coverage should be equivalent or broader than the coverage afforded on the underlying general liability, automobile liability and employers liability grant within the workers compensation policy.

F. Other requirements

Certificates of Insurance evidencing the above required coverages must be provided to the Conservancy at the execution of contract. Certificates of Insurance must be provided naming the following entities as Certificate Holders:

- Rose Fitzgerald Kennedy Greenway Conservancy, Inc.; 185 Kneeland St.; Boston, MA 02111

- City of Boston; One City Hall Square; Boston, MA 02201
- Massachusetts Department of Transportation; 10 Park Plaza, Suite 3170; Boston, MA 02116

Insurance Carriers must be authorized to write business in the Commonwealth of Massachusetts and have a minimum AM Best Rating of A- VII. Certificates must specify the current AM Best Rating of each insurance carrier providing insurance to Contractor.

Certificates must also specifically state the above entities are named as additional insureds on the general liability, automobile liability, and umbrella liability policies. The certificate must also state that the coverage is being afforded to the additional insured on a primary and non-contributory basis.

All policies required must include a waiver of subrogation, waiving all of Contractor's rights against the Conservancy, The City of Boston, and the Massachusetts Department of Transportation. Certificate must note the same. The workers compensation policy must be specifically endorsed as such.

The certificate should indicate that 30 days' notice of cancellation or nonrenewal to each certificate holder will be provided. Any "endeavor to provide notice" should be deleted. The policies must be specifically endorsed to provide notice to the certificate holders.

Failure to provide property and casualty insurance certificates meeting the requirements detailed herein could result in revocation of acceptance and denial of access to The Greenway.

All insurance required must be maintained throughout the duration of the contract. If at any time during the Term of Contractor's contract with the Conservancy evidence of current insurance is not on file with the Conservancy, then Contractor's right to occupy its designated Location(s) and provide Services will be suspended until Contractor provides the Conservancy with acceptable evidence of the required insurance.

4.4 SUBMISSION

RFP proposals must be submitted electronically by **2/7/25 at 5pm**. All materials should be emailed as attachments (no more than 25MB in total file size) to:

rtzen@rosekennedygreenway.org with "**Greenway Masonry RFP**" as the subject line.

V. EVALUATION PROCESS

The Conservancy will evaluate all Proposals in accordance with the provisions of this RFP, based on the criteria described below. In its evaluation, the Conservancy may consider all information contained in the Contractor's Response and any other information obtained by the Conservancy.

The Conservancy will award the contract in accordance with the "CONTRACT AWARD" section below. Before awarding the Contract, the Conservancy may conduct interviews with selected Respondents. The purpose of the interviews will be to clarify and assure understanding of the

contents of the Response, as well as the requirements of the RFP and the Contract, discuss with the Respondent deficiencies or uncertainties in its Response, discuss cost and fee information, and discuss any other matters relevant to such Response. No statements made or actions taken by any representative of the Conservancy during such discussions shall be binding on the Conservancy. If requested by the Conservancy, some or all of the key personnel identified in the Response may be required to participate in the discussions or to be available for an interview with Conservancy representatives.

5.1 EVALUATION CRITERIA

The criteria listed below will be applied to evaluate the Proposals .

A) Best Value

The Conservancy shall select the Contractor, based on the Conservancy's assessment, in its sole discretion, of which Proposal represents the Best Value to the Conservancy, For purposes of this RFP, "Best Value" shall mean the most advantageous combination of multiple criteria, including but not limited to the following: quality, economic value, timely performance, the procurement and use of recycled products and environmentally preferable products and services, minimal administrative burden, expediency, and flexibility in developing alternative business relationships. The contract determined to provide the Best Value will not necessarily be the lowest cost contract.

B) Best and Final Offer

At any time after submission of Proposals and prior to awarding the contract, the Conservancy shall have the option to provide Respondents with an opportunity to provide a "best and final offer" and may limit the number of Respondents selected for this option.

5.2 CONTRACT AWARD

The Conservancy reserves the right to reject any and all proposals if it determines that such action is in the best interest of the Conservancy.

This RFP is not binding on the Conservancy. The Conservancy assumes no responsibility for the costs incurred in the preparation of a Response or related activities. This RFP and Response Form have been prepared solely to solicit Proposals, and are not contract offers. The only documents that will be binding on the Conservancy are the Contract duly executed by the Conservancy and the Contractor.

Proposals shall be considered a firm offer and shall remain effective unconditionally for six months.

5.3 BOARD APPROVAL

In all cases, the award of the contract shall be subject to the approval of the Members of the Board of Directors of the Conservancy.

VI. TERMS AND CONDITIONS

6.1 PROCUREMENT AMENDMENTS

The Conservancy may, at any time prior to the execution of a definitive contract, and without penalty, amend an RFP or change the procurement requirements, scope, budget or procurement schedule upon notice to Respondents. Any amendment shall be issued by means of written addendum. Any and all addenda so issued shall become part of the RFP.

6.2 PROJECT BUDGET AND SUBDIVISION OF CONTRACT

The Conservancy anticipates selecting one contractor to complete the scope of work identified above. However, the Conservancy reserves the right to subdivide the project if advantageous based on the Best Value definition outlined in Section 5.1A of this RFP.

The combined 3 year project budget of approximately \$450,000 is based on the Conservancy's current Capital Repairs funding agreement with MassDOT. If at any point this funding source is altered or eliminated, the Conservancy may not be able to guarantee the current budgeted amount to the selected contractor.

6.3 PROCUREMENT CANCELLATION

The Conservancy may for any reason, and at any time prior to the execution of a definitive contract, and without penalty, notify Respondents of a cancellation of a competitive procurement process and the rejection of all Proposals .

6.4 CORRECTIONS TO A SUBMITTED RESPONSE

The Executive Director of the Conservancy shall determine whether to allow the correction of errors or omissions in a Response.

6.5 REFERENCES

The Conservancy shall have the right to request references, in addition to any references or examples of past projects specified in the RFP, at any time during the procurement process and at any time during the period of contract performance. The Conservancy may verify any references included in a Contractor's Response and conduct any other reference or credit checks as it deems appropriate. The Conservancy may consider any written references, including documentation of performance records of a Contractor on file at the Conservancy or solicited from any other entity, documentation of reference checks or other documentation solicited by or submitted to the Conservancy during the procurement process.

6.6 DISQUALIFICATION

A) The Conservancy may disqualify any Response that it determines to be unresponsive, including, but not limited to:

- (1) Proposals that are received after the deadline for submission specified in an RFP.
- (2) Proposals that fail to meet, address or comply with material requirements in an RFP, including instructions for submission, content or format.
- (3) Proposals that indicate collusion or unfair trade practices by one or more Respondents agreeing to act in a manner intended to avoid or frustrate the process described herein or any law or regulation.
- (4) Proposals submitted by a Contractor, or which identify a subcontractor, currently listed on the Conservancy's "Non-Qualified Contractor" list.
- (5) Proposals submitted by a Contractor which has an actual or potential conflict of interest, as determined by the Conservancy's Audit and Risk Management Committee, based on the information disclosed on the Response or on any other credible information regarding the Contractor obtained from any reference or other source.
- (6) The failure of the Conservancy to reject a Contractor whose Response is otherwise non-responsive or unacceptable shall not preclude the Conservancy from subsequently rejecting such Response.

B) In addition to the foregoing, a selected Contractor's Response shall be disqualified if the Conservancy determines that the Contractor:

- (1) is intentionally or unreasonably delaying the timely execution of a definitive agreement;
- (2) negotiates in bad faith;
- (3) refuses to execute a definitive agreement; or
- (4) is unable to reach final agreement on contractual terms with the Conservancy within a reasonable time as determined by the Conservancy.

C) If a selected Contractor's Response is disqualified for any reason, the Conservancy may (but shall not be required to) negotiate a contract with the next Best Value qualified Contractor.

6.7 DISCLOSURE

No Contractor shall make any news release or announcement, or hold any press conference, concerning its selection or non-selection for a contract prior to the Conservancy's public release of said information.

As a non-profit committed to transparency and subject to the Public Record Law, bidder's proposals may become public information at some point.

6.8 CONTRACT AND AMENDMENT NEGOTIATION

The Conservancy may negotiate with the selected Contractor prior to execution of a contract, and with the Contractor after a Contract has been executed, with respect to cost, scope, or any other term or aspect of the work that is the subject of this RFP.

6.9 CONFLICT OF INTEREST

The contract shall require that the selected Contractor provide the Conservancy with notice of any actual or potential conflict of interest that arises in connection with its performance of the contract as a result of obligations it has to another client or as a result of any other business relationship, and shall reserve the right of the Conservancy to terminate this contract as a result of any such potential or actual conflict of interest.

Exhibit A: Fee Proposal

Task	Unit	Unit Price
Cut out and repoint mortar joints	LF	
Cut out and apply polymeric sand at mortar joints	LF	
Cut out and re-caulk sealant joints	LF	
Remove and reset granite paving 2" thickness	SF	
Remove and reset granite paving 3" thickness	SF	
Remove and reset granite paving 4" thickness	SF	
Remove and reset granite pavers/stairs 4"-6" thickness	SF	
Remove and reset North End fountain granite paving	SF	
Remove and reset granite veneer	SF	
Patch/repair granite	EA	
Replace granite curb	LF	
Skate stop installation (Type1)	EA	
Skate stop installation (Type 2)	EA	
Skate stop installation (Type 3)	EA	
Skate stop installation (Type 4)	EA	
Skate stop installation (Type 5)	EA	
Skate stop installation (Type 6 - Dots)	EA	
Reset/replace skate stop	EA	
Unit pavers new installed	SF	
Remove and replace concrete unit pavers	SF	
Remove and replace concrete fan pavers	SF	
Remove and replace CIP concrete walk	SF	
Remove and replace brick paving	SF	

Exhibit B: Description of Area to be Serviced

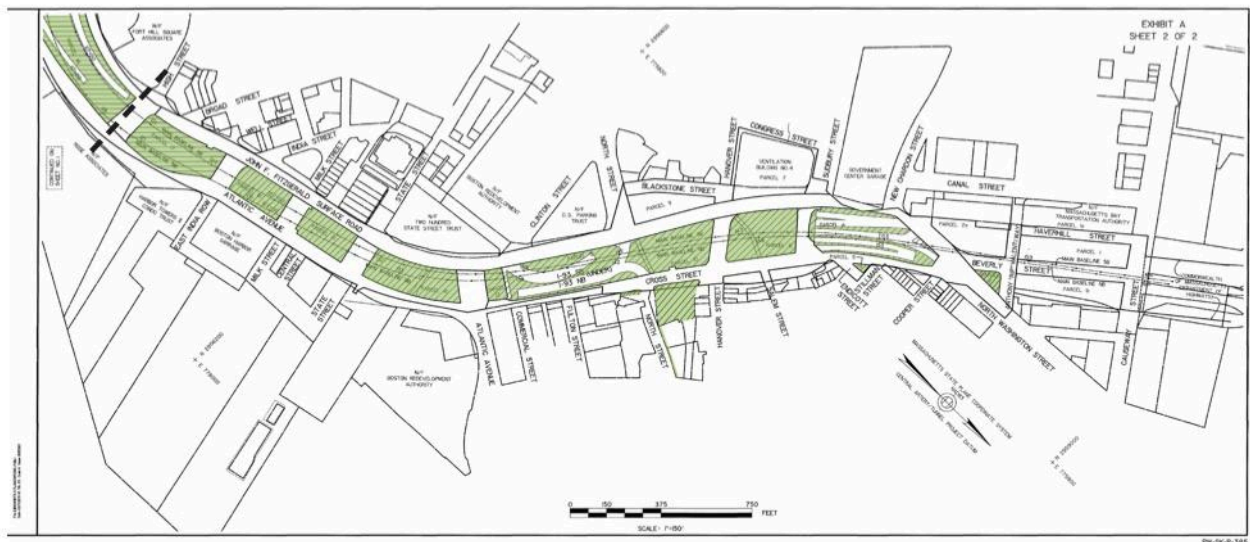
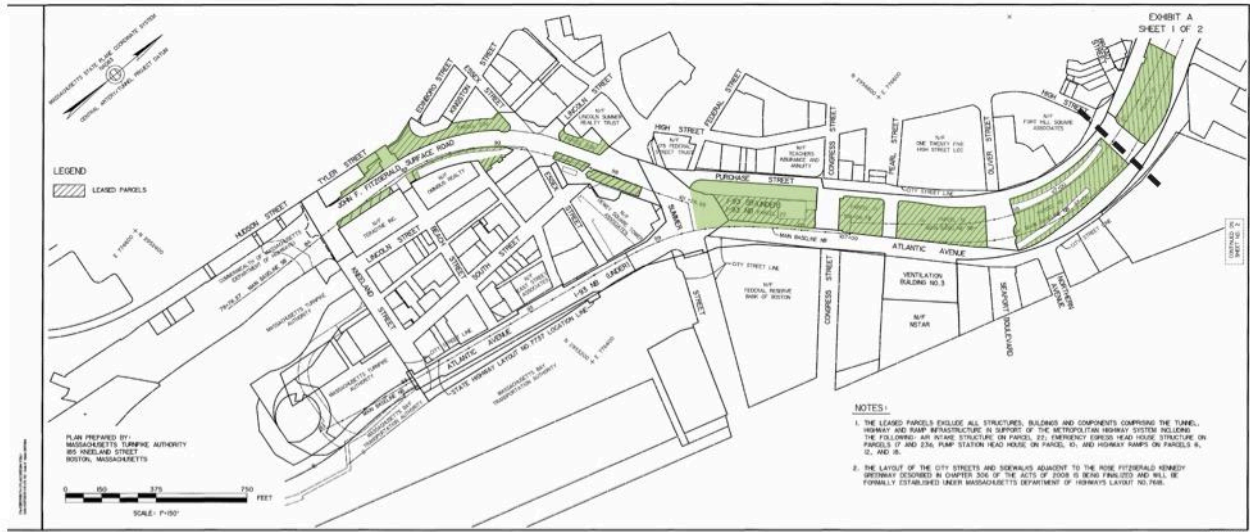

Exhibit C: Park Use Guidelines

----- See document that follows -----



185 Kneeland Street
Boston, MA 02111
617.292.0020

Rose Kennedy Greenway Park Use Guidelines for Public Programming, Special Events and General Use

Rose Fitzgerald Kennedy Greenway Conservancy, Inc.
Adopted: June 2010; Revised December 2018

TABLE OF CONTENTS

- I. BACKGROUND ON THE ROSE FITZGERALD KENNEDY GREENWAY CONSERVANCY, INC.
- II. PUBLIC USE AND ENJOYMENT
 - A. DEFINITION OF GREENWAY PARK PROPERTY
 - B. OPEN HOURS AND PARK REGULATIONS; EMERGENCY CONTACT
- III. PUBLIC PROGRAMS AND EVENTS: GUIDELINES AND APPLICATION PROCESS
 - A. PROGRAMMING VISION AND PRINCIPLES
 - B. APPLICATION PROCESS - RESERVATIONS, PERMITS AND EVENT MANAGEMENT COSTS
 - C. EVENT POLICIES
- IV. APPENDIX A: MAPS OF THE ROSE KENNEDY GREENWAY PARKS
- V. APPENDIX B: CURRENT FEE STRUCTURE

I. BACKGROUND ON THE ROSE FITZGERALD KENNEDY GREENWAY CONSERVANCY, INC.

The Conservancy is the designated steward of the Rose Kennedy Greenway, a mile-and-a-half of contemporary parks in the heart of Boston that connect people and the city with beauty and fun. The non-profit Conservancy maintains, programs, and improves The Greenway on behalf of the public and in partnership with the Commonwealth of Massachusetts.

The Massachusetts Department of Transportation (MassDOT), which owns the land that comprises The Greenway, has entered into a lease agreement with the Conservancy for the management, maintenance and operation of The Greenway (the MassDOT Lease), in accordance with Chapter 306 of the Acts of 2008, as amended by Chapter 242 of the Acts of 2012 (the Enabling Act).

II. PUBLIC USE AND ENJOYMENT

A. DEFINITION OF GREENWAY PARK PROPERTY

The Greenway park property governed by these Park Use Guidelines is defined by the Enabling Act and by the MassDOT Lease. These documents can be found on the Conservancy website: www.rosekennedygreenway.org.

B. OPEN HOURS AND PARK REGULATIONS; EMERGENCY CONTACT

1. **Park Operating Hours:** To maintain a safe and secure environment at all times, general operating hours for The Greenway parks are from 7:00 AM to 11:00 PM. No park use, except for pedestrian passage through The Greenway along the park paths, is allowed from 11PM-7AM, except with the specific prior approval of the Conservancy.
2. **Park Operating Rules and Regulations:** Certain park rules are posted in The Greenway for the information of park visitors. Use of The Greenway shall be in accordance with the following rules and regulations, as well as all applicable City and State laws, ordinances, regulations, and policies.
 - a. **Organized Athletics, Fitness Classes:** Please note that there are no athletic facilities on The Greenway. To avoid wear and tear on the parks and probable conflict with other park users, organized sports, fitness classes, and other repetitive, active uses of The Greenway shall be permitted only with the specific prior approval of the Conservancy. Please see Section III for event permit details.
 - b. **Unauthorized Vehicles:** To ensure the public's safety and protect park furniture and planting beds, skateboards, segways, rollerblades, bicycles, Pedi cabs, scooters, personal motorized devices and horse-drawn carriages are prohibited. Driving these vehicles or unauthorized vehicles of any type is prohibited in the parks. Motorized personal devices required by persons with impaired mobility are permitted. Park visitors with a bicycle, skateboard, scooter, etc. must dismount and walk with it while in the parks. Bike lanes are located on the public streets that run along either side of The Greenway; use Atlantic Avenue for northbound travel and Surface Road for southbound travel.

The Conservancy works with MassDOT, the City of Boston, and other public and private stakeholders to increase accommodation for bicycles along The Greenway corridor.

- c. **Pets:** To ensure clean, safe spaces for a wide variety of users, strict on-leash and clean-up policies will be enforced within The Greenway. "Clean up after your pet" practices are required. Dogs and other pets are not permitted in any of the park fountains, water features, or planting beds. Per City ordinance, dogs must be kept on a leash no longer than eight feet. Conservancy staff reserve the right to ban specific dogs or other pets from the premises at their discretion if such animals pose a hazard

or nuisance.

- d. Littering, Dumping, and Unattended Property: Littering in the park is prohibited. Park users shall utilize receptacles provided for the disposal of refuse. No person shall deposit household or commercial refuse in any park receptacle. No person shall store or leave unattended personal belongings within or adjacent to any Greenway park.
- e. Obstruction of Sitting Areas and Open Areas: No person shall use benches, other seating areas, or open space, for storing or maintaining belongings or other materials, or otherwise use such areas for other than their intended use, so as to interfere with their use by other persons.
- f. Fountains and Water Features, Park Buildings, Monuments, Structures: No person shall use any fountain, water feature, drinking fountain, or any other water within the park for the purpose of washing or cleaning himself or herself, his or her clothing or other personal belongings, or for washing any animal under his or her control. It is prohibited for any person to spit or expectorate in or upon any fountain or water feature, or park building, monument or structure.
- g. Trees and Other Vegetation: It is unlawful for any person to cut, injure, deface or damage any tree or plant on park property. No signs or related hardware (ropes, wires, nails, staples, etc.) are to be attached to any tree. Pets, bicycles, and other vehicles shall not be tied, locked, or otherwise attached to any tree or plant. No chemicals, cleaners, pesticides, or other liquids are to be deposited in the park. BBQ's, portable gas grills, heat generating equipment, and materials shall not be placed near any tree trunks or under the branches of any tree. Because the tree root zone is critical to the overall health of the tree, particular attention will be paid to protection of this vulnerable area from vehicles, turf aeration, material storage, special event equipment, heavy pedestrian traffic and dog damage.
- h. Disorderly Behavior: Disorderly behavior in the park, including but not limited to the examples set forth below, is prohibited:
- vandalism;
 - obstructing or rendering dangerous any part of a park or park path, or otherwise obstructing pedestrian traffic;
 - fighting or assaulting any person;
 - sexual activity;
 - any course of conduct or act that endanger the safety of others;
 - throwing stones or any other objects;
 - setting fires or dropping a lighted match, cigarette, cigar or other burning substance; and
 - having or discharging any firecracker or fireworks.
- i. Alcohol: Alcohol consumption in the parks is prohibited except with the prior approval of the Conservancy and any City agencies or departments responsible for licensing such consumption. Permits for serving or consuming alcohol must be obtained and all applicable City and state laws, ordinances, rules, and regulations apply.

- j. Smoking: Smoking is prohibited in all Greenway parks. Cigarette “butlers” are located in key areas at popular entrances to the parks.
- k. Glass: Due to safety concerns, no glass containers are allowed in Greenway parks without prior approval of the Conservancy.
- l. Care of Park Infrastructure and Plant Materials: The following rules are in effect in order to protect The Greenway parks and the safety of park visitors:
- Seating is restricted to grass areas, park furniture, benches and walls designed for such purpose (granite and seawall areas). It is prohibited to sit, lie, or climb on any balustrade, railing, fence, wall, roof, monument, fountain, shrub, tree or other park element not meant to accommodate seating. Lying down on park benches is prohibited.
 - Visitors shall not enter any flower bed or restricted lawn; or dig up, cut, break, remove, deface, defile, or take part of any tree, shrub plant, turf, rock, gravel, soil, building, structure, fence, railing, sign or other thing connected affixed to or located within the parks.
 - For lawn health, the Conservancy shall from time to time close lawns for aeration, over-seeding, rest, and recovery.
 - It is forbidden to disturb any bird's nest, eggs or young of any wildlife; injure or take possession of any wild animal or bird; or set any trap or snare.
- m. Photography and filming: Use of The Greenway for commercial photography/film/videography, or other such use that is potentially disruptive to regular park use, must apply for a permit from the Conservancy. See Section III for application procedures. Permission from any individuals photographed or filmed for commercial purposes must be obtained. Photographers must leave the park space as they found it and must adhere to all other park rules.
3. Public Safety, Emergencies: Policing in the park is performed by the Boston Police Department. For emergency assistance, please call 911.

III. PUBLIC PROGRAMS AND EVENTS: GUIDELINES AND APPLICATION PROCESS

A. PROGRAMMING VISION AND PRINCIPLES

These guidelines provide a framework both to assist those wishing to hold events on The Greenway with useful planning information, and to ensure continual informal enjoyment of the parks.

As keeper of this public park, the Conservancy's primary goal is to keep the park open for public use. The Greenway Conservancy curates innovative park experiences, consistent with its stewardship of a beautiful and welcoming Greenway. The Conservancy balances park activation—such as fitness classes, concerts, markets, performances, exhibits, celebrations, and other events and gatherings – with the need to ensure passive enjoyment of the park and to provide excellent care of the horticultural collections, the sidewalks and paved areas, the fountains, and the lawns. Regularly scheduled festivals, concerts, markets, and events, are open and free to the public; these free events numbered ~400 in 2016. The Conservancy works collaboratively with companies, organizations, and other groups seeking to hold public events on The Greenway; the Conservancy itself organizes and funds a limited number of activities and events.

Demonstrations and other expressions of free speech on The Greenway are guaranteed by the Constitution of the United States, subject to such reasonable regulations as the Conservancy and/or the City of Boston may apply consistent with these Guidelines and applicable law. Demonstrations and the exercise of free speech rights taking place at or near programs, events, or other activities are allowed so long as such protest is not disruptive to such activity. Rules for public assembly established by the City of Boston will apply. If a demonstration or other expression of free speech requires any set up (including but not limited to tables and chairs, tents, podiums, or amplified sound), a permit is required from the Conservancy and any other applicable City agencies or departments.

The Conservancy may accommodate appropriate fee-based and private uses. For example, the Conservancy permits and/or operates park-appropriate revenue-generating uses, such as food vending and The Greenway Carousel at the Tiffany & Co. Foundation Grove.

- The Conservancy may permit public, ticketed events such as performances, but they will annually be fewer than 10% of the number of free Greenway events. Public, ticketed event proposals must propose to share revenue with the Conservancy to financially benefit The Greenway.
- The Conservancy may issue temporary licenses for private use of small areas of park space (<2000 SF and <5 hours in duration). Private licensed uses will incur fees to financially benefit The Greenway.
- Any event that is not free and open to the public must be planned to minimize disruption of public access and enjoyment of The Greenway. At all times, at least 90% of Greenway

acreage will be available for public enjoyment.

- The Conservancy may hold up to four fundraisers annually in the parks to benefit The Greenway.

The Conservancy may permit events or grant private licenses that depart from these guidelines only with advance written approval from MassDOT.

B. APPLICATION PROCESS - RESERVATIONS, PERMITS AND EVENT MANAGEMENT COSTS

The event permitting process is designed to manage the overall park schedule, maintain a balance in park activation, protect park infrastructure, and avoid conflicts with existing permitted events or with scheduled maintenance by the MassDOT or the Conservancy. Any use of The Greenway requiring a permit under other provisions of these Guidelines shall be subject to this Section III (B). In general, all public and private classes, performances, exhibits, celebrations, and other events and gatherings requiring set up of tables, chairs, booths, tents, or any other equipment, require a permit as set forth herein, as does the sale or promotion of any product or service within The Greenway. The Conservancy reserves the right to require a permit for any other use of The Greenway that may interfere with the public's use and enjoyment of the parks or with The Conservancy's or MassDOT's maintenance of the parks, or that may cause excessive wear or damage to The Greenway.

If the Conservancy grants an event permit, the applicant shall be subject to the Conservancy's rules and regulations, to all applicable federal, state and City laws, ordinances, regulations, and policies, and to the specific terms of such permit.

Permit application process

The first step is to submit a Reservation Form to the Conservancy (www.rosekennedygreenway.org/events/event-proposal.htm). An individual applicant must be at least 18 years of age.

See the maps of each park in Appendix A for easy visual reference and dimensions. Guidance on appropriate locations for different events will be provided by Conservancy staff during the event approval process.

Larger events may then be required to obtain permits through the City of Boston's Special Events process. Applicants are responsible for securing all necessary permits and approvals from the applicable City departments, which may include, but are not limited to, Boston Police Department, the Boston Fire Department, the Boston Inspectional Services Department, and the Boston Entertainment Licensing Board. Conservancy staff will work with the event organizer, assisting them with the process. The City of Boston's special event permit is accessible at www.cityofboston.gov/arts/guidelines.asp

Conservancy Staff Assistance

Park programming is overseen by the Conservancy staff. The Conservancy coordinates with MassDOT and all appropriate City departments, including the Boston Parks and Recreation Department, the Boston Police Department, the Boston Fire Department and EMT Services, the Department of Transportation, the Health Department, the Special Events Office, and any other City entities that regulate events.

At least one Conservancy staff person is assigned to each event leading up to and during an event. Conservancy services may include:

- on-site meetings and visits to review program needs;
- assistance to obtain appropriate permits;
- telephone and email correspondence;
- marketing and community outreach;
- on-site staffing during the event installation; and,
- break down and additional clean up as required.

Insurance

Insurance coverage (including workers comp, auto, general liability, and umbrella insurance) will be required for most events. If the Conservancy requires insurance, the City of Boston, MassDOT, and the Rose Fitzgerald Kennedy Greenway Conservancy, Inc. must be named as additional insured. On a case by case basis a bond or other security may be required to cover the costs of possible cleanup, repair of damage, and equipment removal.

Information about public programming

Information about public programming will be distributed through the use of the Conservancy website, periodic brochures and postcards, direct community outreach at community meetings, Conservancy public meetings, and Conservancy social media channels.

Event Management Fees

Based on the nature, size, type of organizational entity, and needs of an event, some fees are required. Revenue generated from fees helps offset the costs of the Conservancy's free programming on The Greenway.

Fees are determined by the following factors, among other considerations:

- Whether the event is corporate, promotional, informational, non-profit, or neighborhood-based;
- The duration and complexity of planning, permitting, load-in and load-out procedures requiring the presence of one or more Conservancy staff beyond normal working hours to assist; and,
- Size of the event. For example, large events using a bigger portion of the park and requiring staff time, permitting and planning, furniture moving and so forth will be subject to a higher fee.

If fees represent a financial hardship for an organizer of a non-commercial event with a significant public benefit, the applicant organization may request special financial assistance from the

Conservancy.

A fee schedule is presented to the Board annually for approval. See Appendix B for current fee structure. It generally includes—but is not limited to—the following categories:

- 1) Non-Refundable Application Fee – paid at time of event proposal submission to the Conservancy

- a. Discounted fee for non-profit organizations
- b. Fee for for-profit organizations

Applications not submitted at least 30 days in advance of the proposed event date will be subject to an additional fee.

- 2) Furniture Moving – The Greenway has hundreds of moveable tables, chairs and umbrellas in in the park. Should furniture need to be relocated, a fee will be charged based on the labor required.

- 3) Programs staff support – Should Conservancy programs staff be required either after normal business hours or on weekends, an hourly fee will apply.

- 4) Commercial and promotional activities - Should an organizer or vendor wish to offer product samples or promote a product, service, or organization, a fee will be charged. The fee will vary based on duration, location, footprint, and nature of event.

- a. Sampling and Promotion – Proposals for giveaways/promotions will be assessed to assure general public enjoyment of the park. Certain set-ups, footprints, and locations may not be possible. Fees will be assessed to assure that there is benefit to The Greenway.

- b. Markets – The Greenway hosts park-appropriate commercial markets, such as farmers' markets or artisans' markets. Fees will be based on a revenue-share.

- c. Other events including commerce – For events with a money-making component for the organizer, a fee will be charged so that there is also a financial benefit to The Greenway. Fees can be structured as an upfront flat amount or as a revenue share, depending on the nature of the event.

- 5) Deposits for damage and cleaning – If a program or event 1) has an expected attendance of more than 1,000 participants, 2) is recurring or 3) proposes to use lawn areas on The Greenway, the Conservancy reserves the right to require a deposit in advance of the event. Lawn replacement and hardscape cleaning fees are on a per-square foot basis, and deposits will be based on the size of the event and the footprint of lawn or hardscape used. All park grounds must be protected from damage during load-in, load-out, and throughout your event. We will work with you to devise an appropriate protection plan. Event organizers are required to leave the park in as good condition as when they began load-in. If trash, debris or additional clean-up is required, the Conservancy may also charge an hourly rate for clean-up in excess of the deposit.

A 50% deposit of the total estimated costs is required three weeks in advance of the event. Final payments are due no later than the start of set-up for the event or program on The Greenway.

C. EVENT POLICIES

ADA Compliance

All events must comply with the Americans with Disabilities Act (ADA) standards. The Greenway is ADA-accessible.

Alcohol

Unless expressly permitted by the Conservancy (and subject to City approvals), the consumption of alcohol is prohibited. Alcohol has been permitted for Conservancy fundraisers and for a limited number of public events.

Amplified Sound

Applicants for event permits must comply with City of Boston sound ordinances relating to amplified sound, including the payment of all applicable fees. Your event may be subject to sound metering for compliance with state and local law.

Catering & Food Preparation

All food uses must comply with relevant city and state health and safety policies and procedures, and pay all applicable fees.

Clean up, Trash Removal & Recycling

The applicant is responsible for site cleanup. The site shall be cleared and cleaned immediately following the event. All waste generated from an event must be bagged and removed from the park at the end of the event. Trash cannot be left next to garbage cans or on the curb. If you need assistance with identifying trash removal and recycling services, please contact the Conservancy. Plaza areas that were used should be swept with brooms & dustpans (metal rakes or other tools that may cause damage are not permitted for clean-up) and washed as needed. Power washing can be performed by the Conservancy or its approved contractor at an additional cost.

Decoration & Event Signage

- Arrangements may be made with the Conservancy's Events Coordinator to display banners or signs.
- The size and location of decorations must be approved by the Conservancy.
- No decorations, signs or related hardware (ropes, wires, nails, staples, etc.) may be affixed to any trees, plants, or other surfaces, walls, or built structures within the parks.
- Because of clean-up issues and the health of small animals, decorating with, and throwing of small confetti-like items such as rice, birdseed, glitter, confetti, rose petals, etc., is not permitted.
- Due to the negative impact on wildlife and the marine environment, balloons are not permitted on The Greenway.
- Unless expressly permitted (and subject to City approvals), fireworks, candles, pyrotechnics and explosives of any kind are not allowed on the premises.

Documentation

The permit holder must have the original approved permit and all documentation required by the City of Boston in their possession at the site while the event is taking place.

Electricity

Electrical needs will be assessed when the applicant makes a site visit with Conservancy staff. Most of the parks in The Greenway are equipped with electricity. It is the responsibility of the applicant to supply additional electricity if needed. Note that use of a generator requires a special

permit from the Boston Fire Department. All equipment for the event, electrical cords, speakers, etc. shall meet the Massachusetts electrical code.

Inclement Weather

The Conservancy encourages lawn use as part of an event for seating and low impact infrastructure (e.g. lawn games, light furniture). Locating equipment (e.g., tents, stages, flooring, tarps, ballast, etc.) on lawns is prohibited without the specific prior approval of the Conservancy. Event organizers planning to use a lawn area as a part of an event must also have an alternate plan in case the approved lawn area becomes unavailable. The availability of all lawn areas depends on weather conditions for the duration of the event from set-up through breakdown. In case of wet conditions, the Conservancy will determine whether the event is to be modified, cancelled or postponed in as timely a manner as possible, but often within 24 hours prior to the event.

Lawn Rest

The regular use of a park for special events causes wear and tear, requiring special maintenance on lawns and other surfaces. The Conservancy reserves the right to limit or relocate an event, depending on the nature of the event, size, and location. The Greenway's lawn care and use management strategies are designed to ensure that the park will continue to be used and enjoyed for many years to come. Key strategies include:

- Lawns are closed when they need to recover from heavy use during large events, when they are especially susceptible to damage (such as when the turf is dormant or wet), and for necessary maintenance.
- Activities and behaviors that can significantly impact the lawns are prohibited (organized sports like soccer or football, vehicles on lawns, etc.)
- Active use of lawns (fitness classes) are rotated regularly to allow sections of turf to recuperate.

Lighting

While the parks are generally well lit, any additional lighting must be permitted by the Conservancy and costs are the responsibility of the applicant. All additional lights need to be free standing, may not be attached to any park infrastructure and need to be aimed carefully so as not to negatively impact abutters.

Parking & Public Transportation

There is no parking on The Greenway. Getting to and from all portions of The Greenway is very convenient by public transportation, please check our website at www.rosekennedygreenway.org for details. For directions from the closest MBTA station, please see the specification pages for each individual park in Appendix A.

Restrooms

There are no public restrooms on The Greenway. Portable toilets may be required for certain events, and costs are the responsibility of the applicant. Public restrooms are located in North Station, South Station, and Faneuil Hall Marketplace, among other locations.

Recycling

In keeping with the Conservancy's commitment to environmentally responsible practices, at special events hosted by any third parties, we strongly encourage recycling of all products that

are used in the parks. Visitors must be able to easily separate their trash from recycling.

Staging, Tents and Other Structures

Placement of staging, tents, lighting, portable toilets, and other structures requires approval from the Conservancy prior to event. All canopies must be weighted instead of staked to avoid damage to electrical, irrigation, and water lines. A stage must be free-standing and not attach to any existing structures for support. No nails or staples shall be attached to any existing surface. Surfaces, including lawns, must be protected at all times. Plywood sheets or other protective barriers must be placed on the ground underneath the stage. Flooring may also be required for certain activities. All permitted equipment for the event, including electrical cords, speakers, pop-tents, etc. must be secured/weighted to keep the public safe at all times.

Tents, decorations or other equipment must be installed and removed the day of the activity, unless permission is granted by the Conservancy in advance. A detailed schedule for event load in and load out is required no later than 15 days before an approved event. The Conservancy will not be responsible for any decorations, signs or other items left after an event. Security for event equipment, decorations, etc. is the responsibility of the event organizer and may be required by the Conservancy.

After an event is over, if any event infrastructure remains after the agreed upon removal time, a per-hour charge will be assessed to the permit holder until the tent and/or other equipment is removed [See Appendix B for current fee structure].

Vehicular Access

There is no vehicular access in any of The Greenway parks without approval from the Conservancy. Proposals should request vehicular access in the event application to the Conservancy, understanding the spaces and access are limited and priority must be given to pedestrian usage of the park. Generally, later or last minute requests cannot be authorized. If approved, commercial auto insurance will be required.

Water

There is no access to potable water on The Greenway, apart from a drinking fountain located on Parcel 14 between Clinton and State Streets. All drinking water must be provided by the event organizer. Water and other liquids used at events must be properly disposed of off-site and not in planting beds or lawns.

IV. APPENDIX A: MAPS OF THE ROSE KENNEDY GREENWAY PARKS

Parks are identified by north/south cross streets.

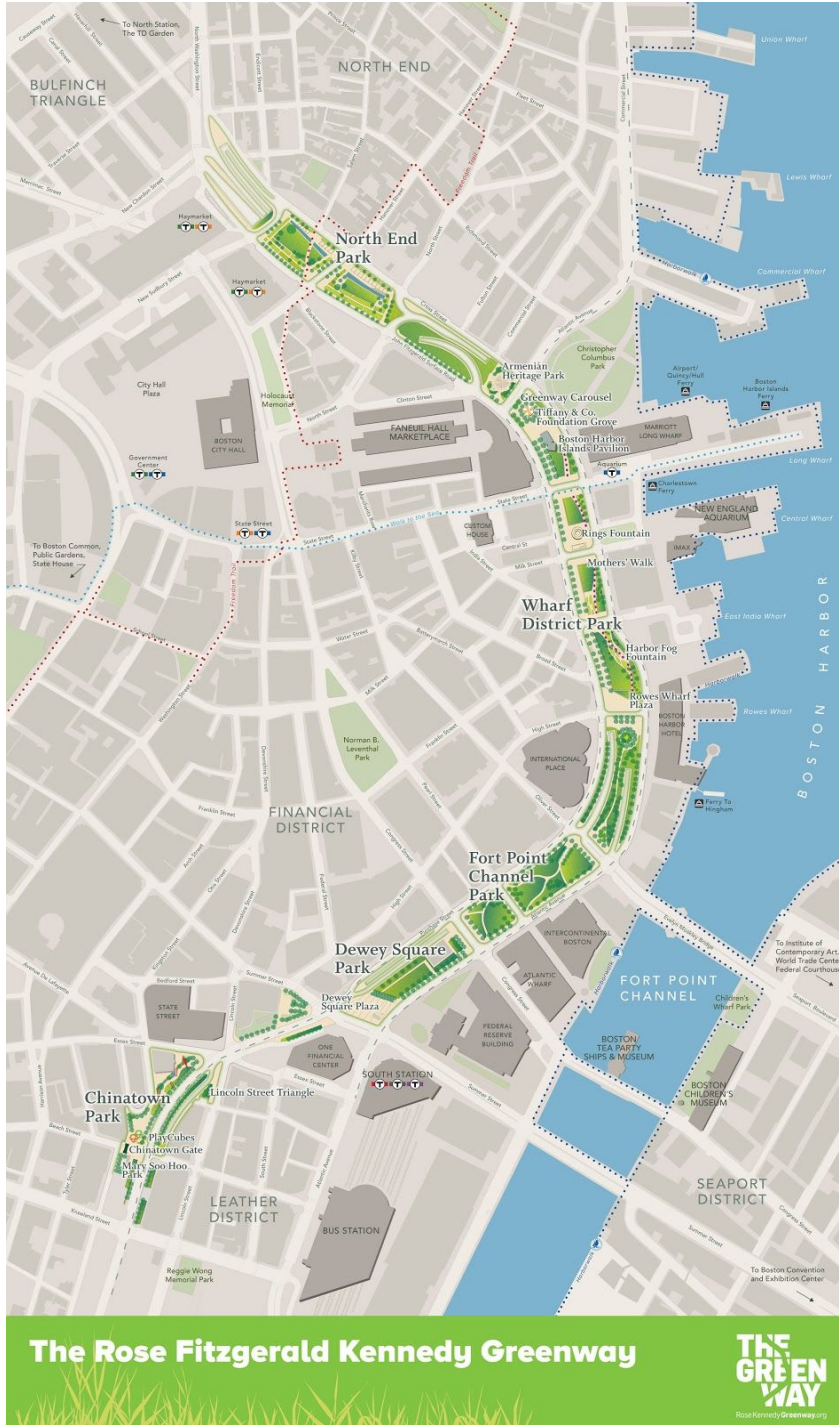

North End Parks

Accessible by MBTA:

Orange Line: Haymarket Station
Green Line: Haymarket Station
Blue Line: Aquarium Station
Commuter Rail: North Station

Parcel 5: Stillman Street and Cross Street

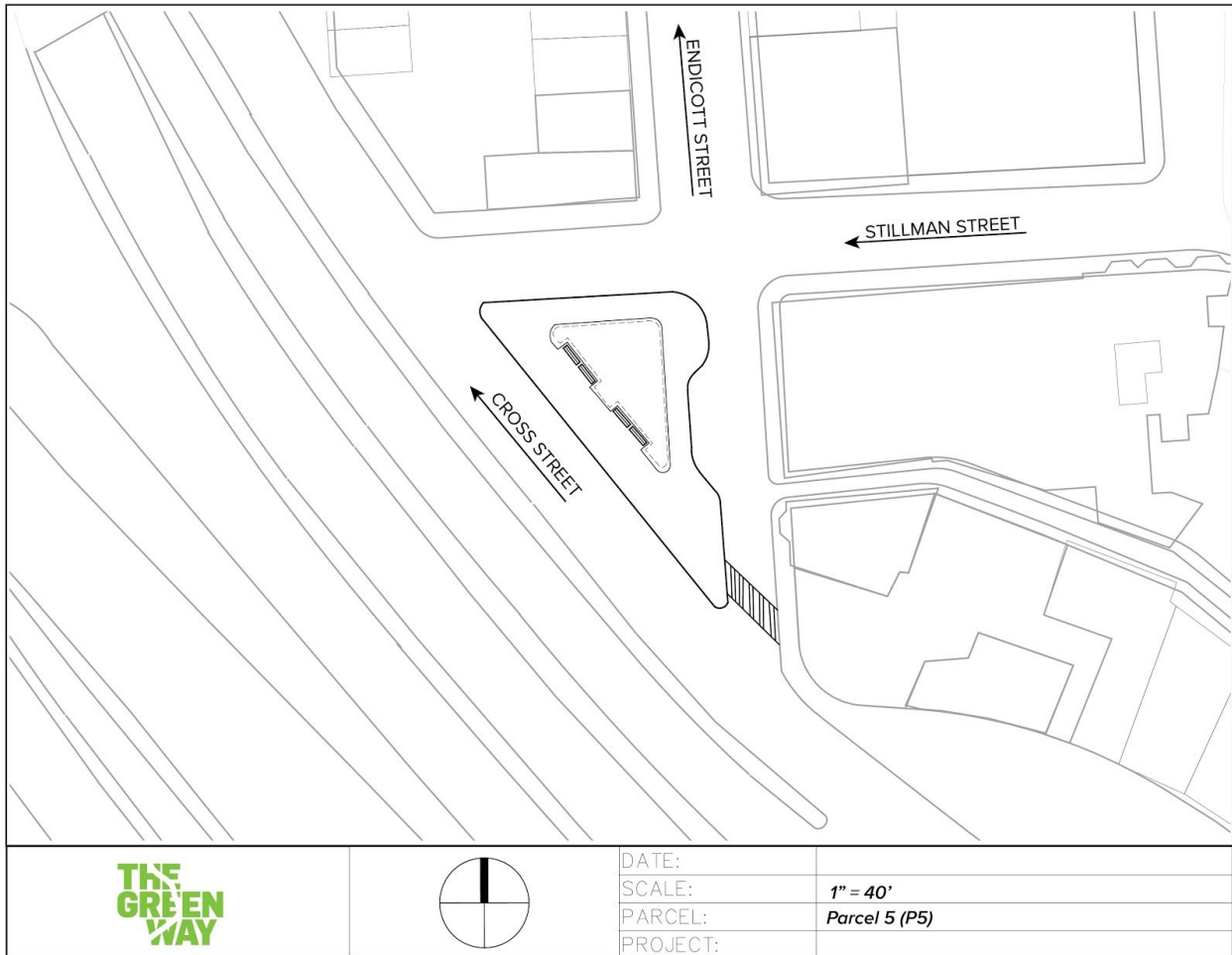

Parcel 6: Cooper Street and Haymarket Square

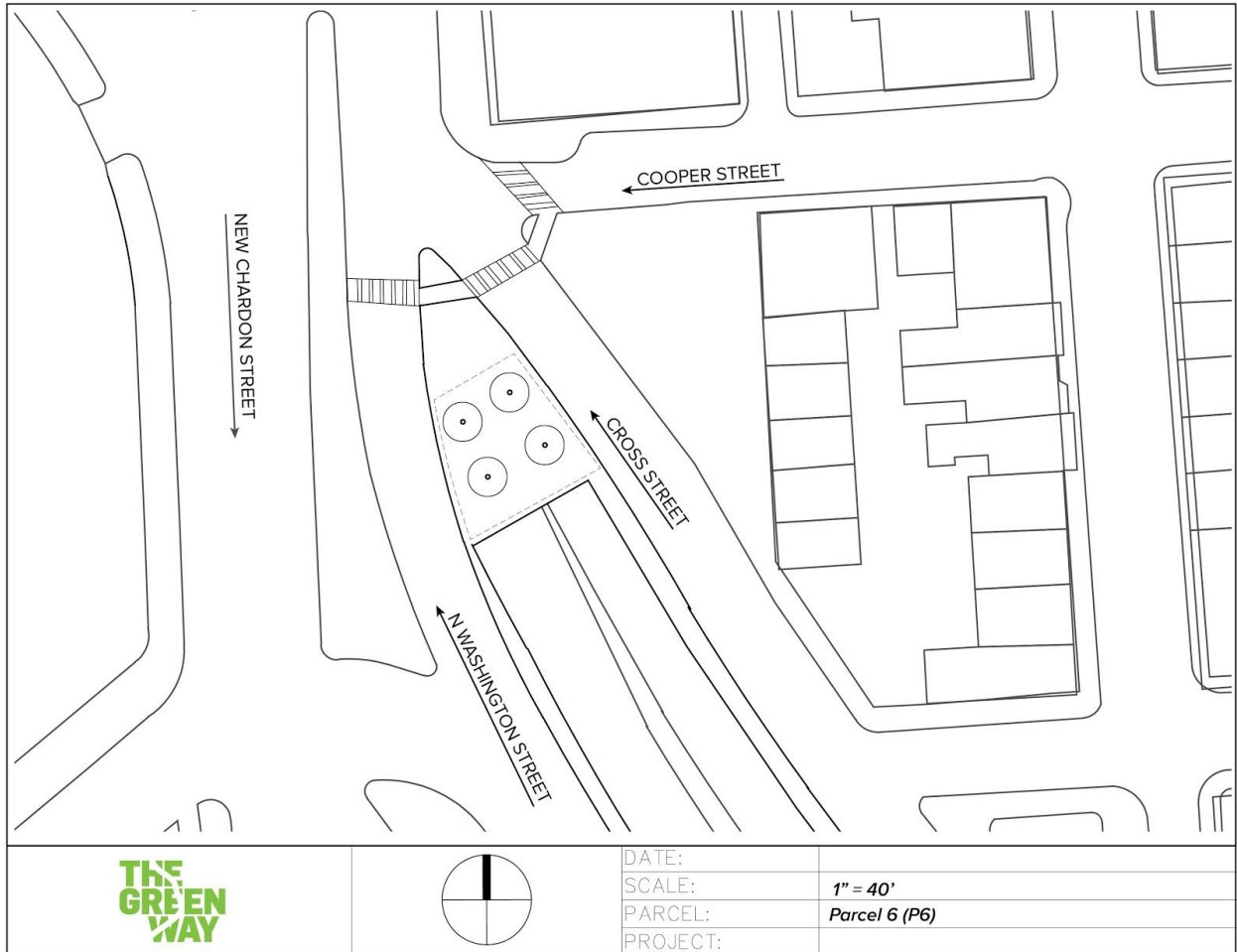

Parcels C, D and E: along Cross Street

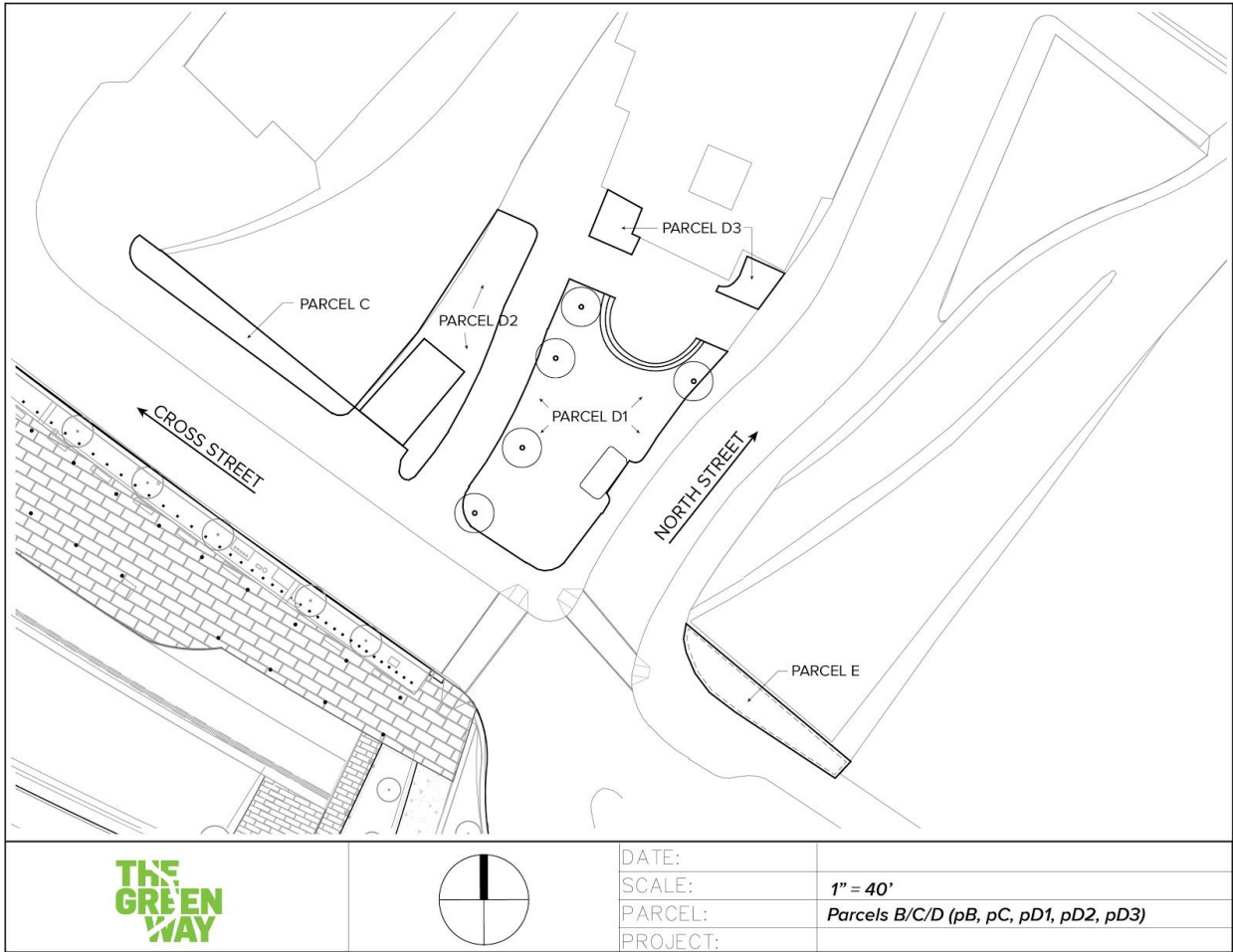

Parcel 8: Hanover Street and Haymarket Square

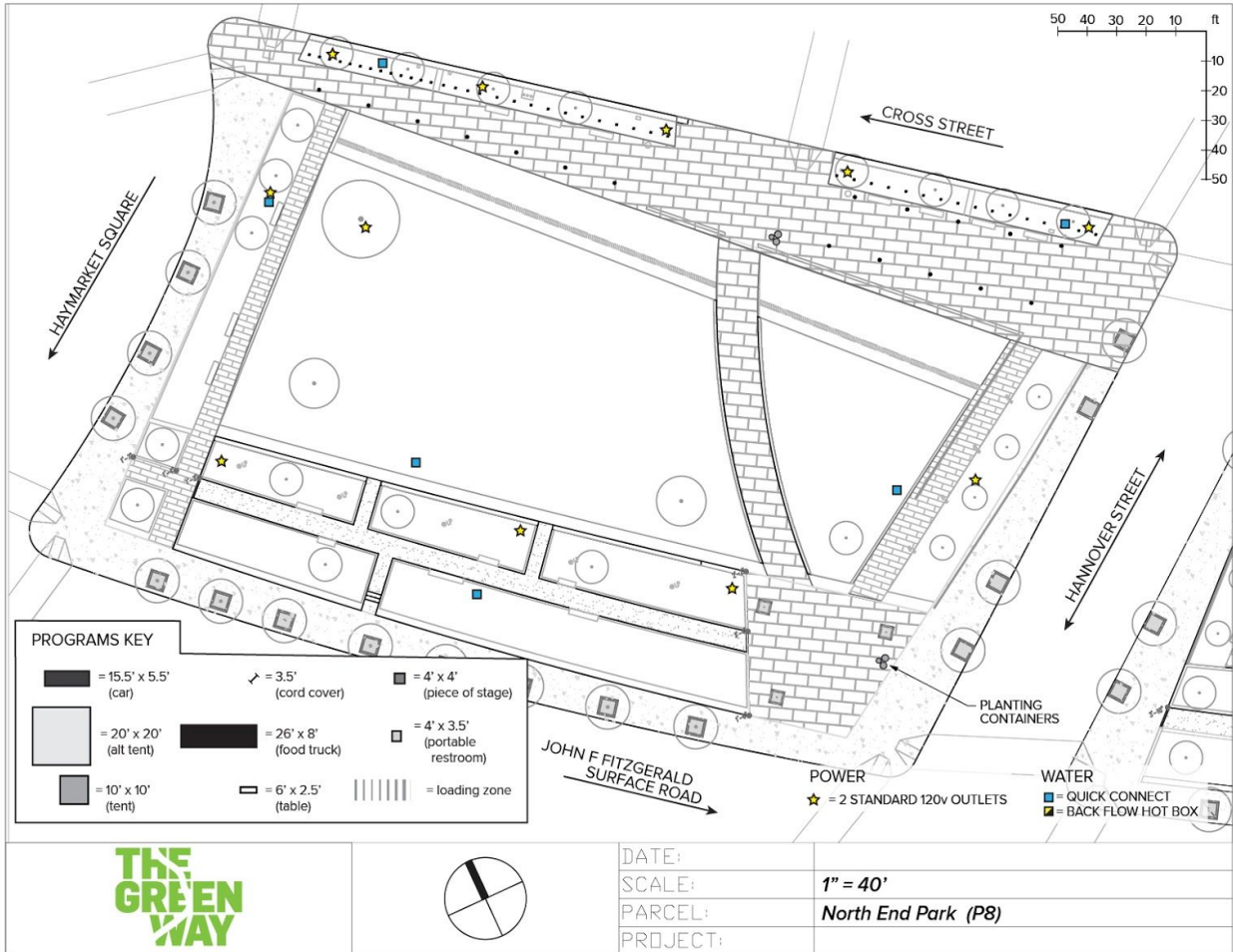

Parcel 10: North Street and Hanover Street

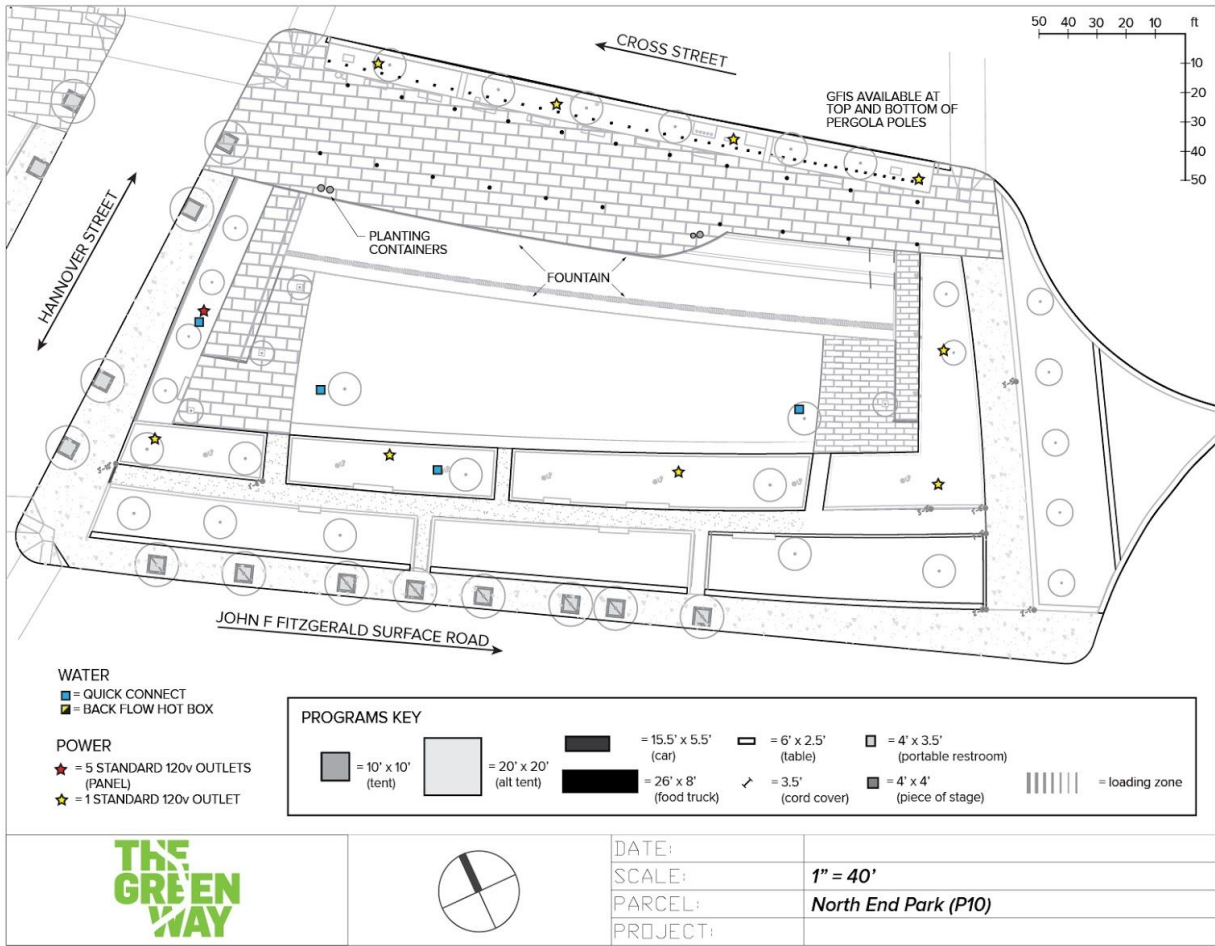

Ramp Parcel

Parcel 12: Clinton Street and North Street

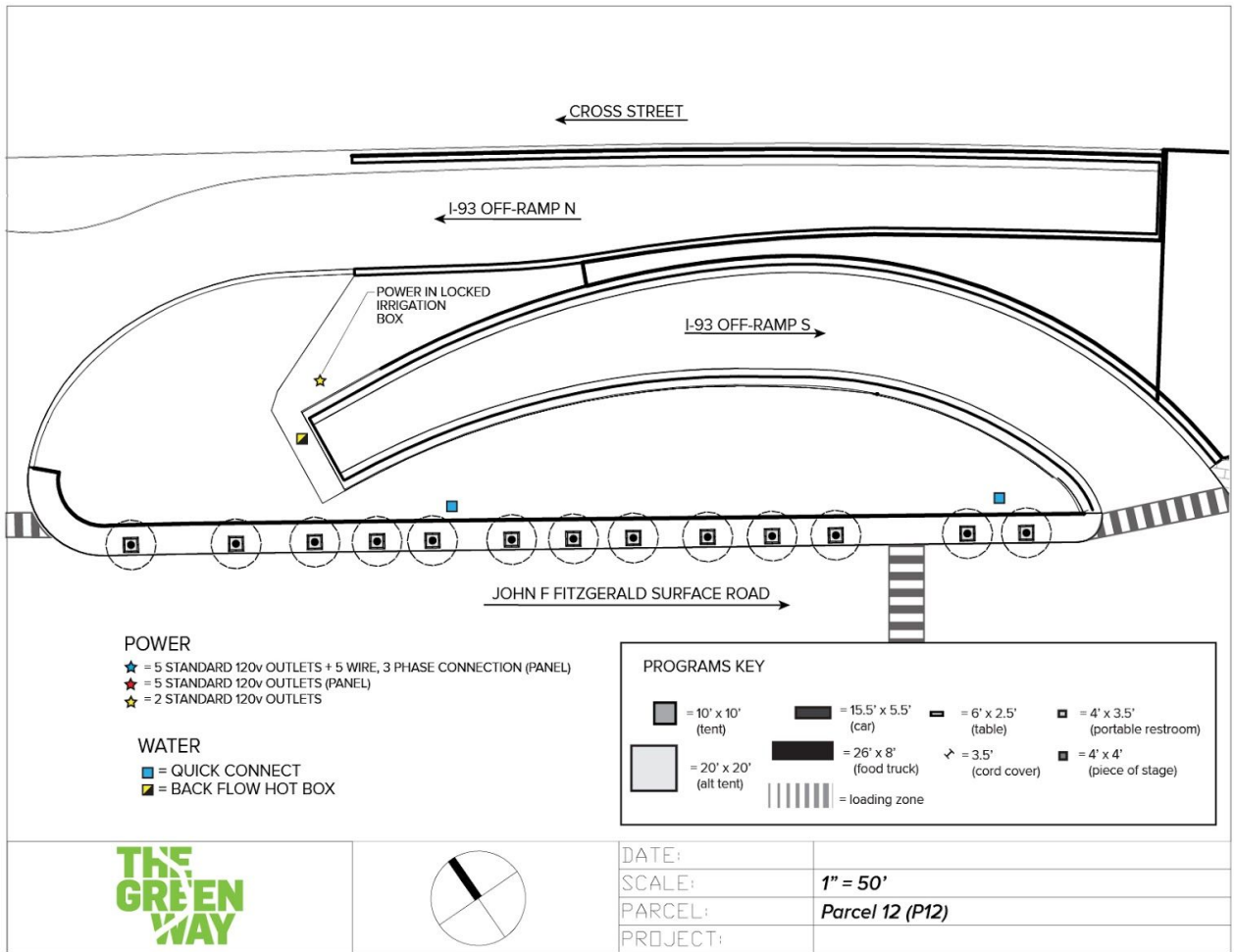

Wharf District Parks

Accessible by MBTA:

- Orange Line: State Street Station
- Green Line: Government Center Station
- Blue Line: Aquarium Station
- Red Line: South Station
- Commuter Rail: North and South Stations

Parcel 14: State Street and Mercantile Avenue

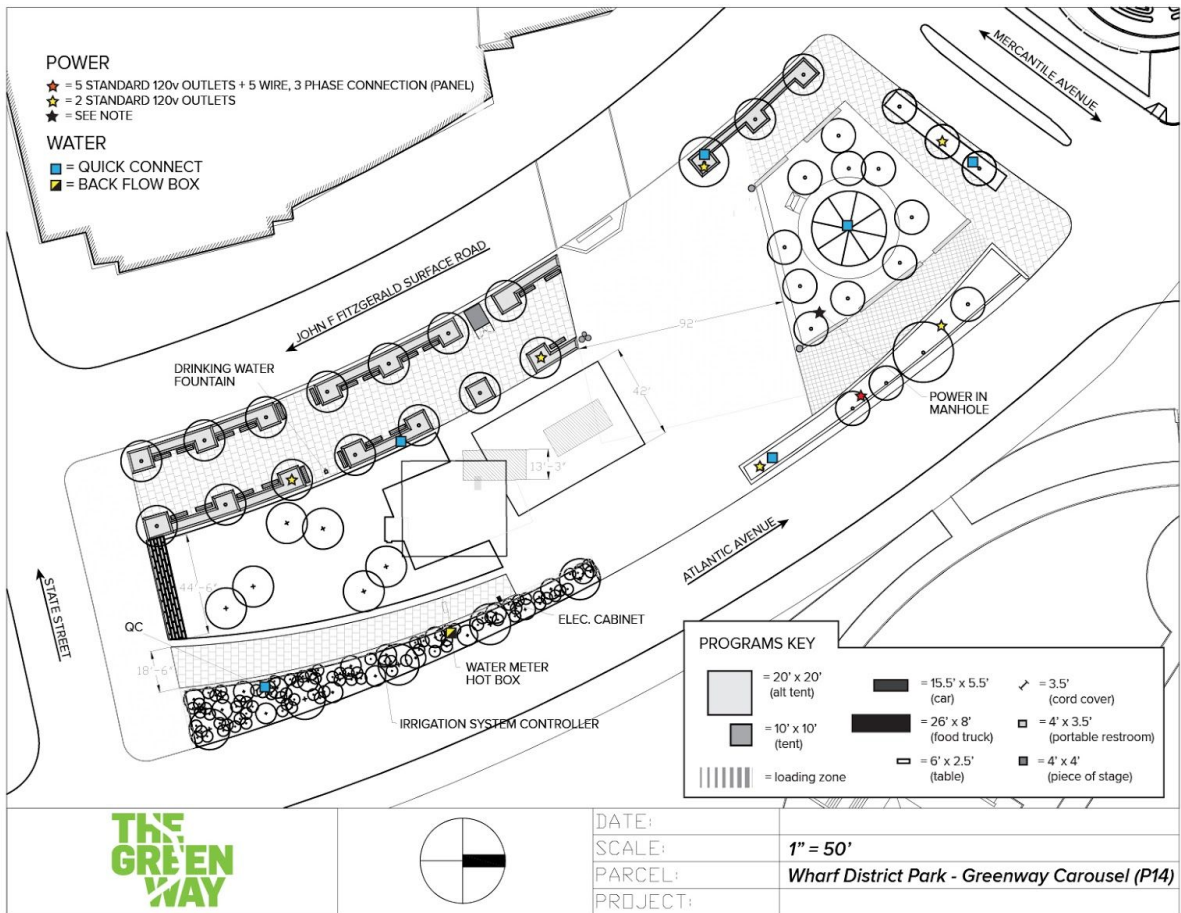

Parcel 15: Milk Street and State Street

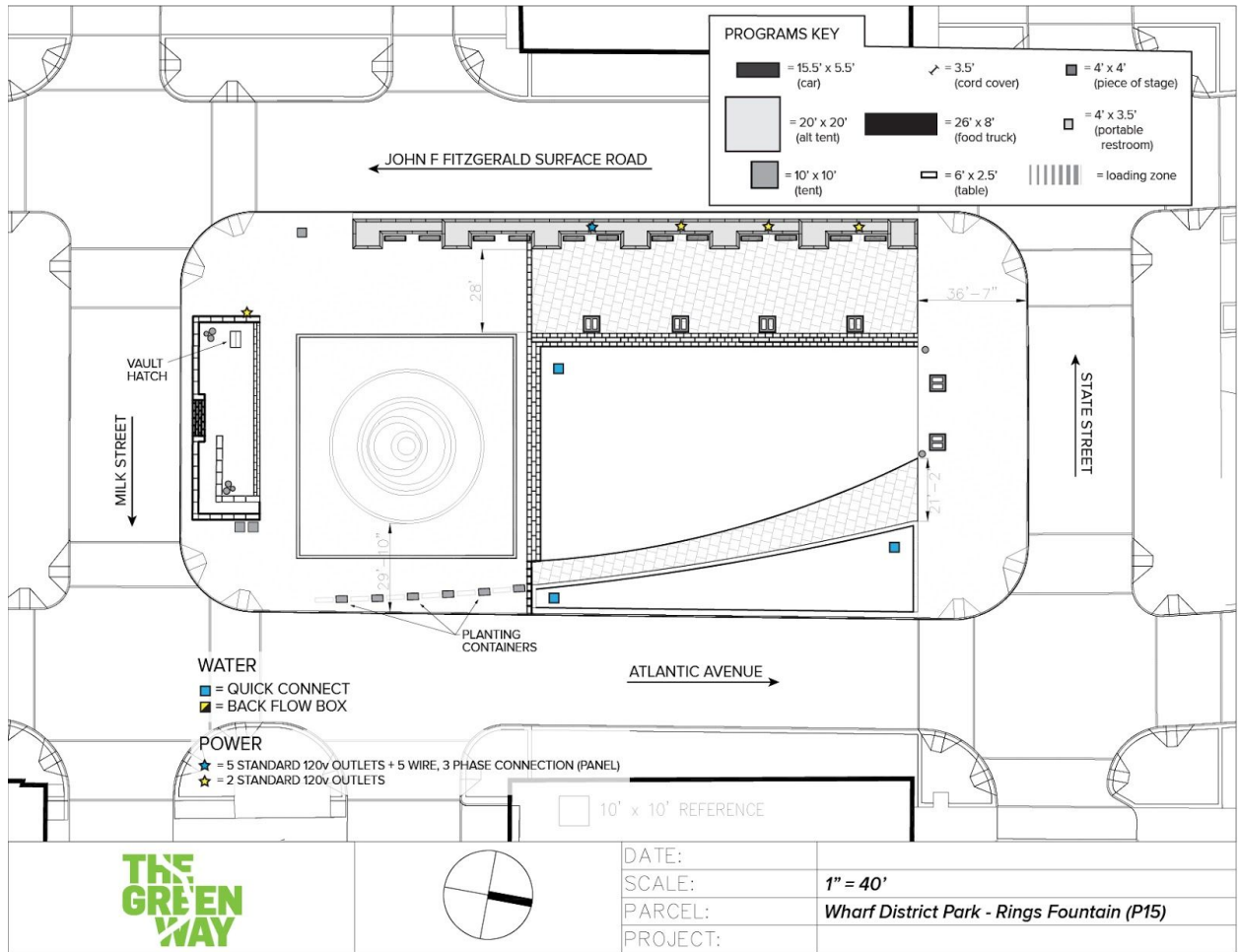

Parcel 16: India Street and Milk Street

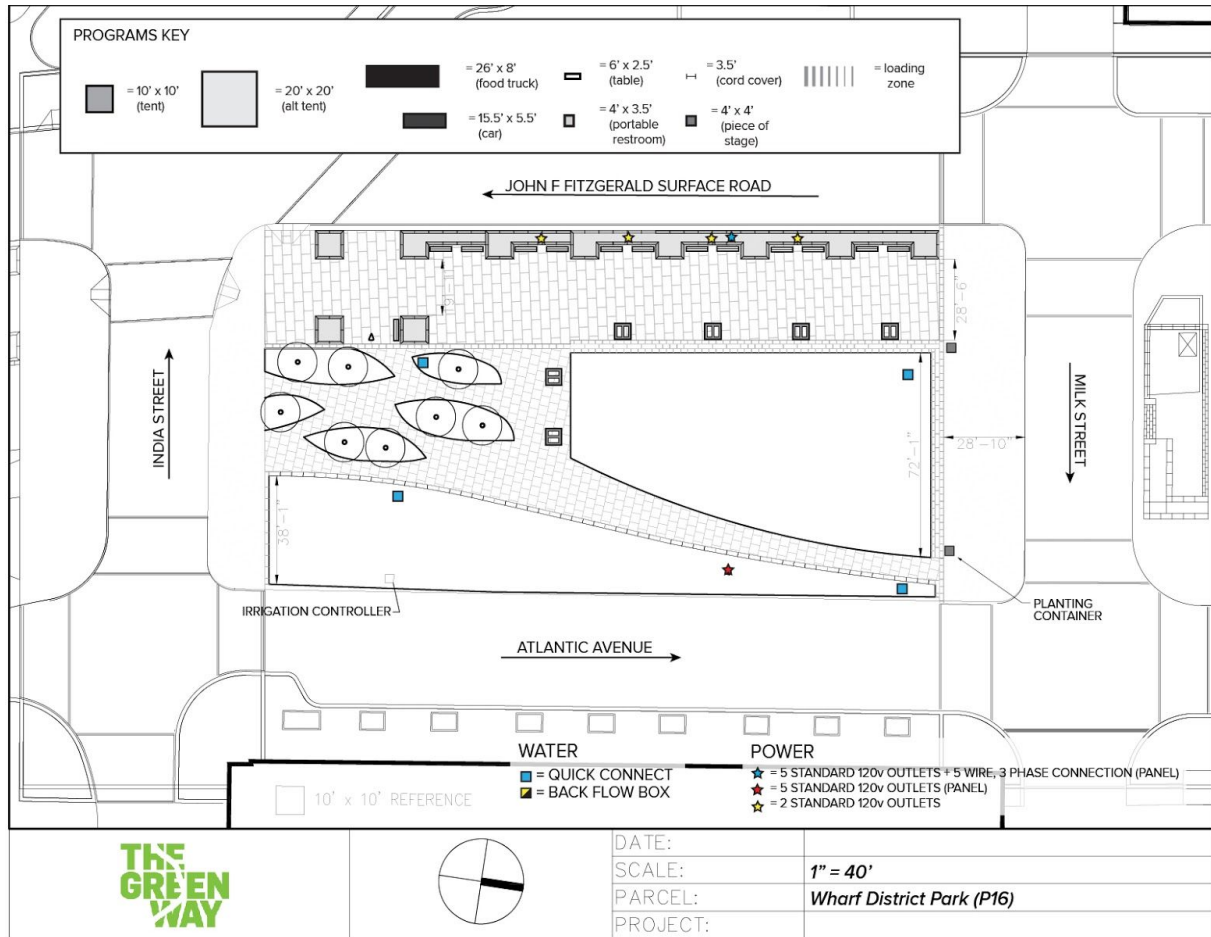

Parcel 17: High Street and India Street

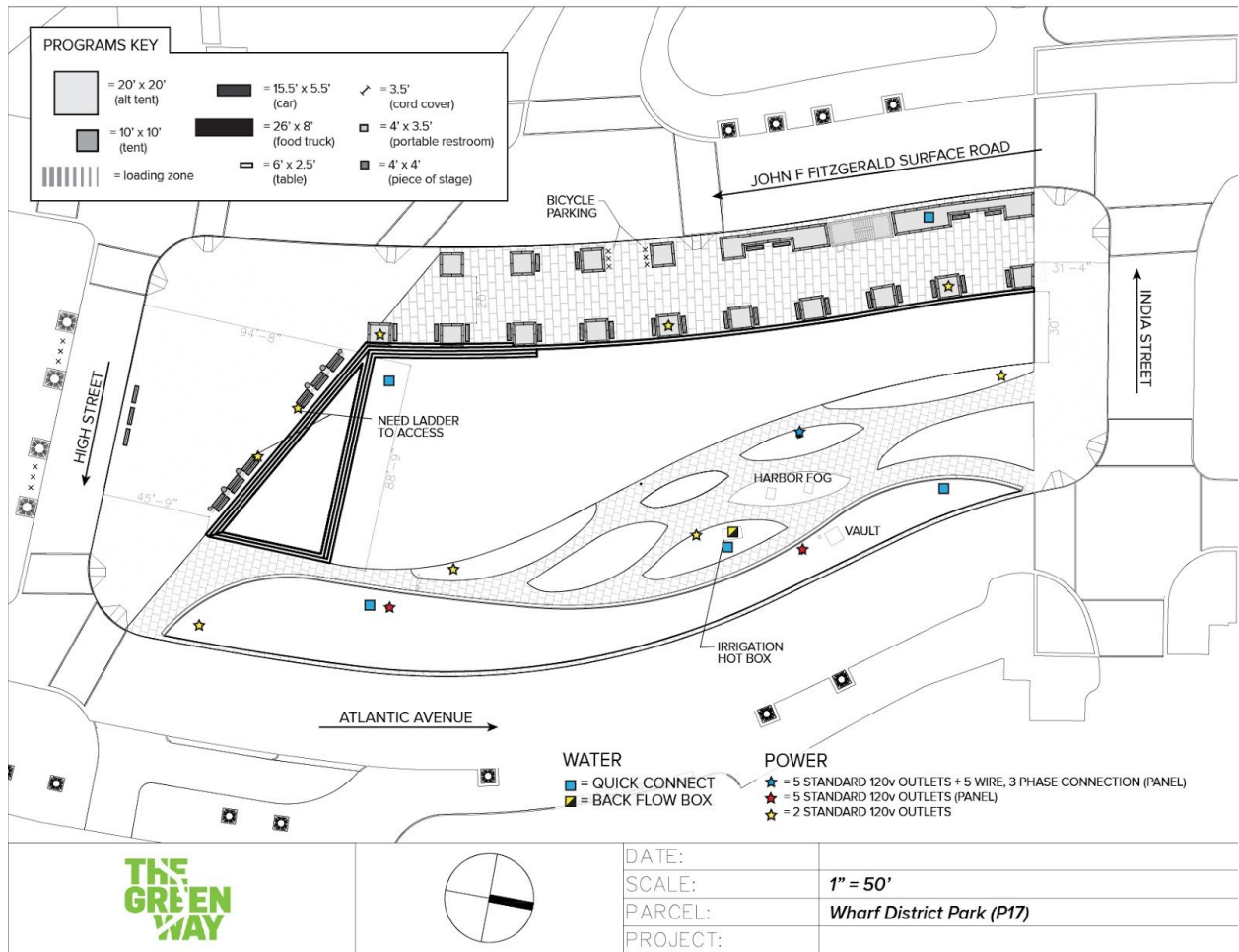

DATE:	
SCALE:	1" = 50'
PARCEL:	Wharf District Park (P17)
PROJECT:	

Parcel 18: Seaport Boulevard and High Street

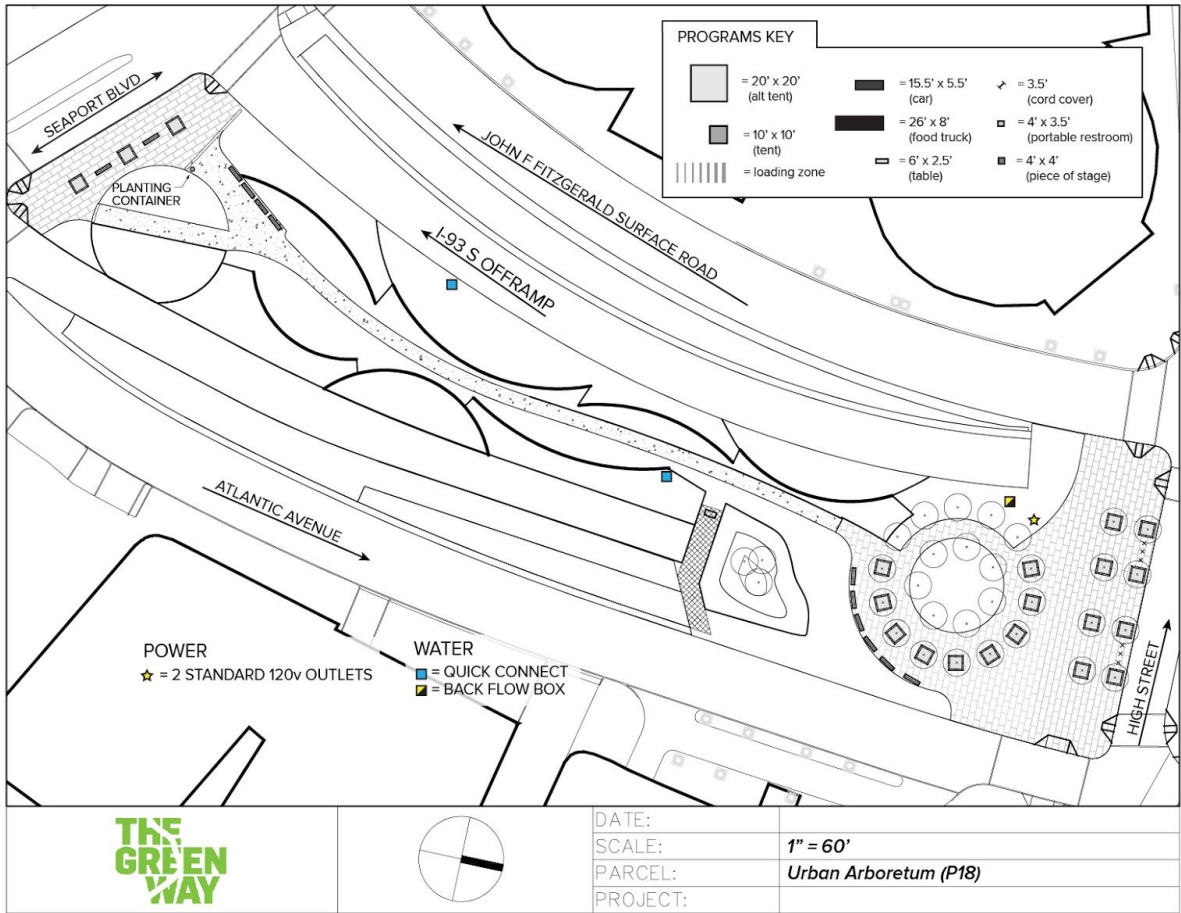

Fort Point Channel Parks

Accessible by MBTA:

Orange Line: Downtown Crossing
 Red Line: South Station
 Silver Line: South Station
 Commuter Rail: South Station

Parcel 19: Pearl Street and Oliver Street

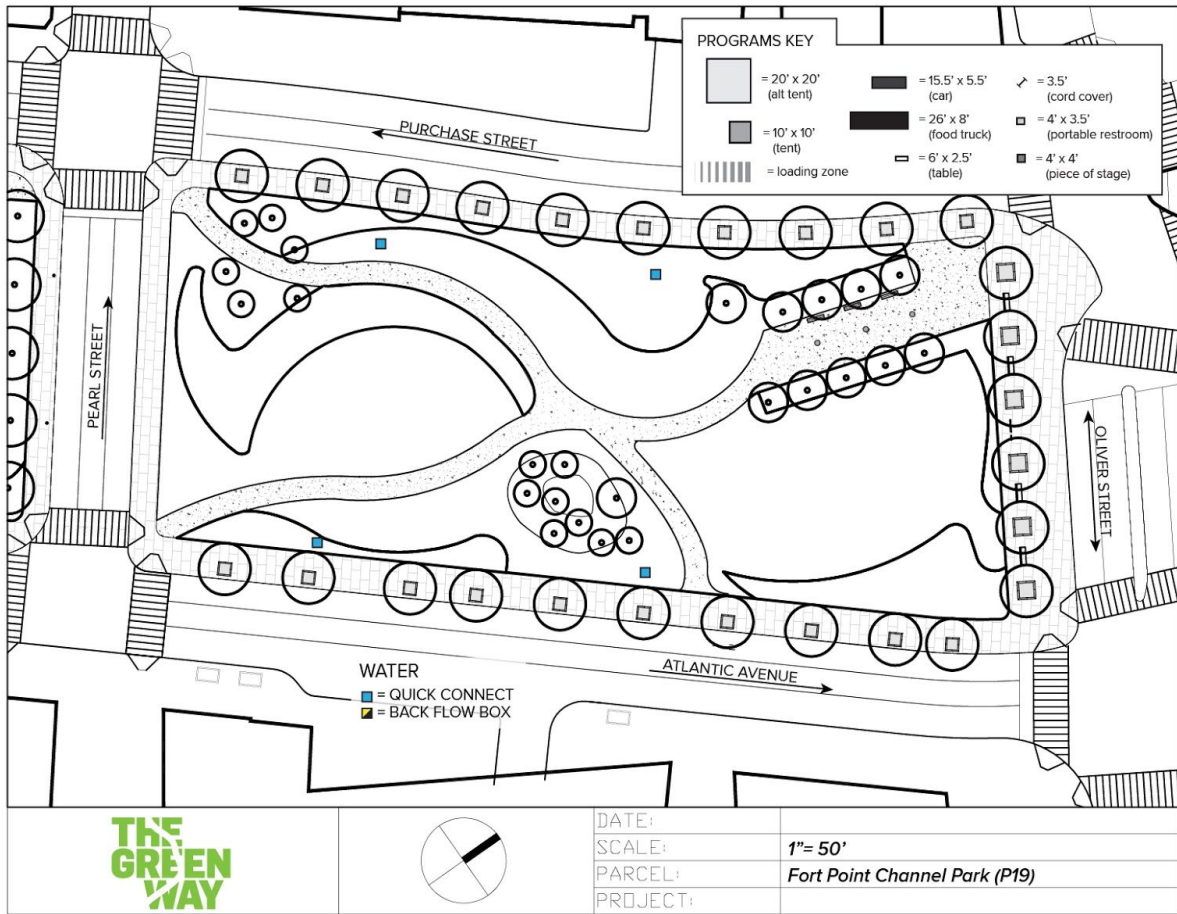

Parcel 21: Congress Street and Pearl Street

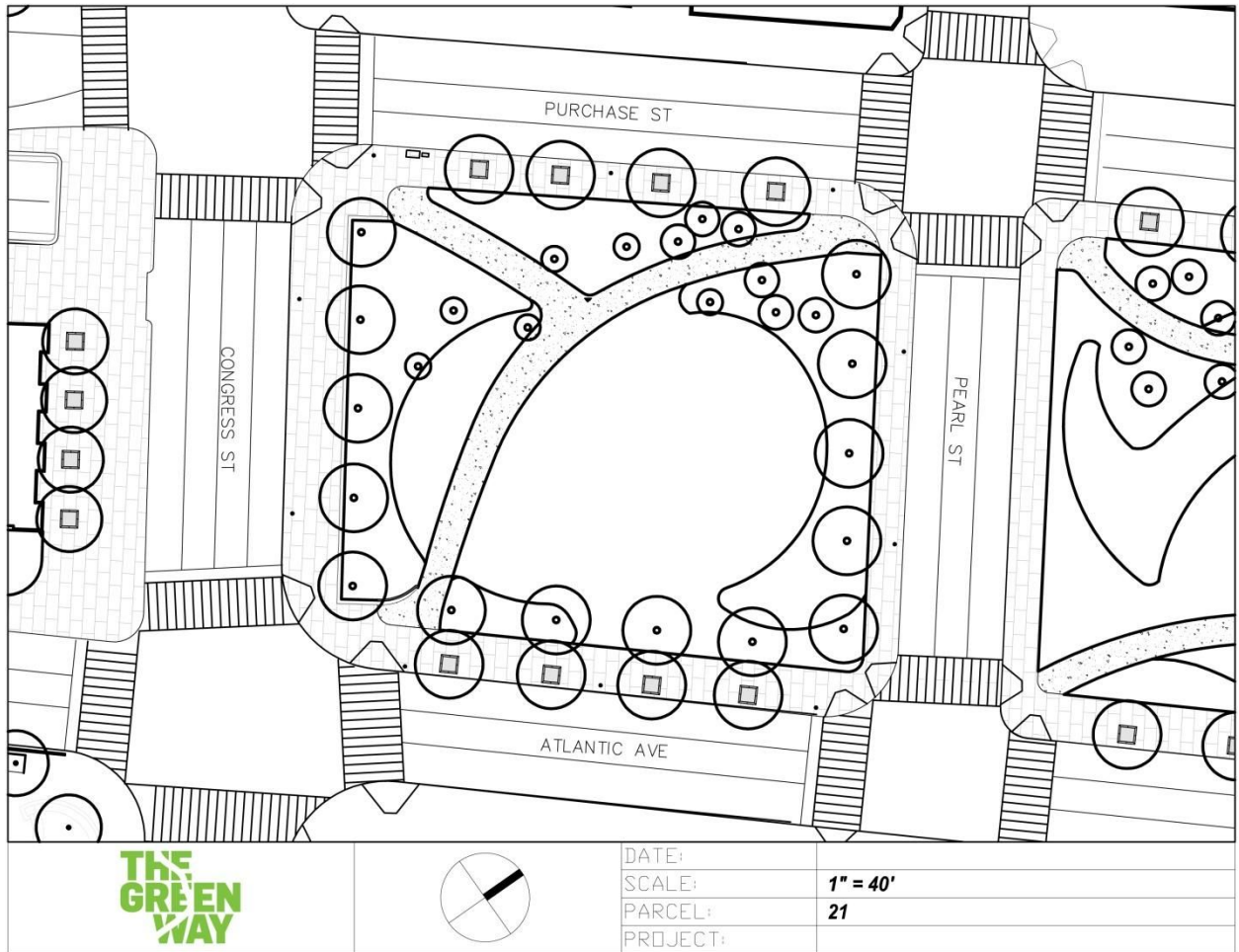

Dewey Square Park
Accessible by MBTA:

Orange Line: Downtown Crossing
 Red Line: South Station
 Silver Line: South Station
 Commuter Rail: South Station

Parcel 22: Summer Street and Congress Street

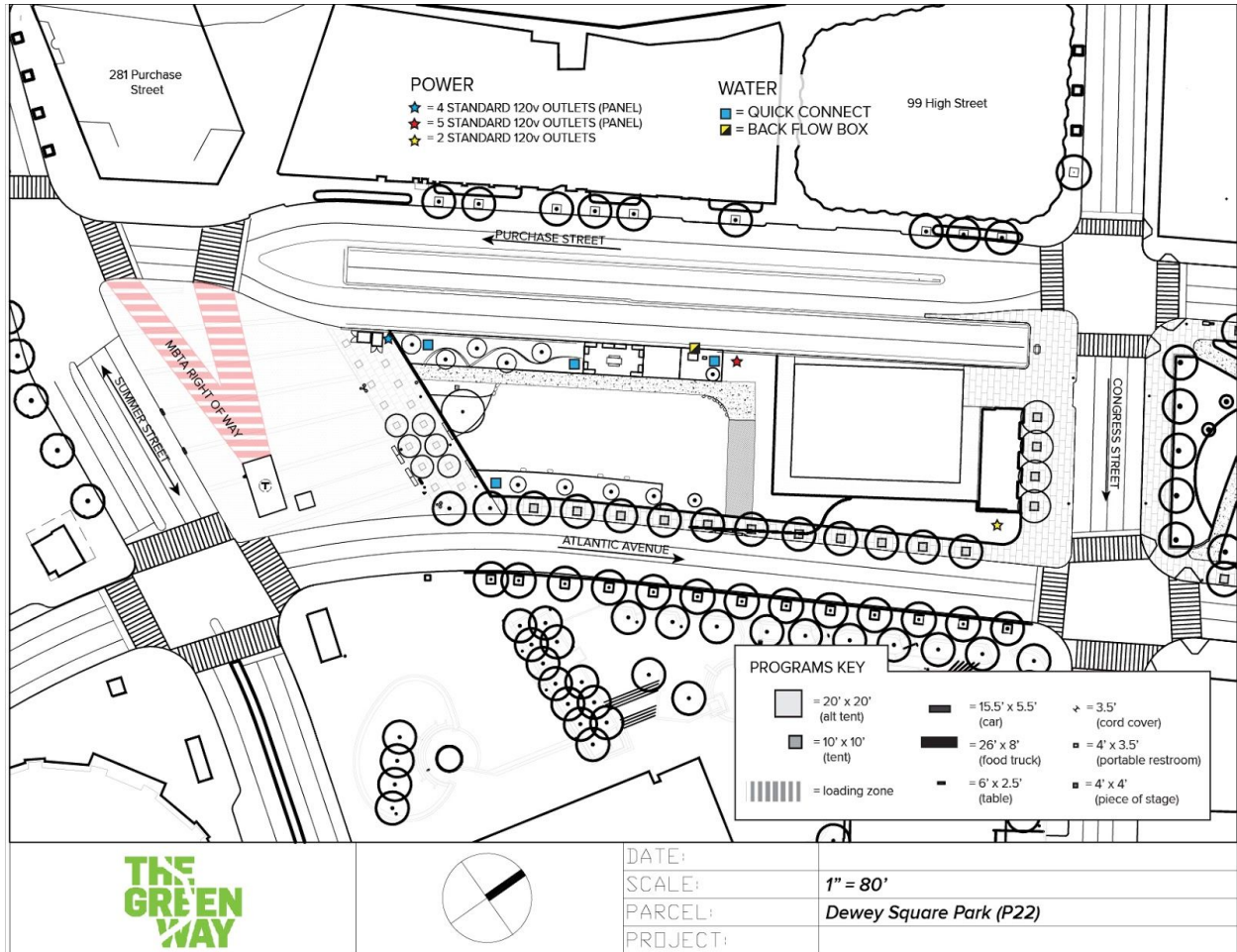



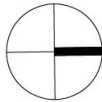
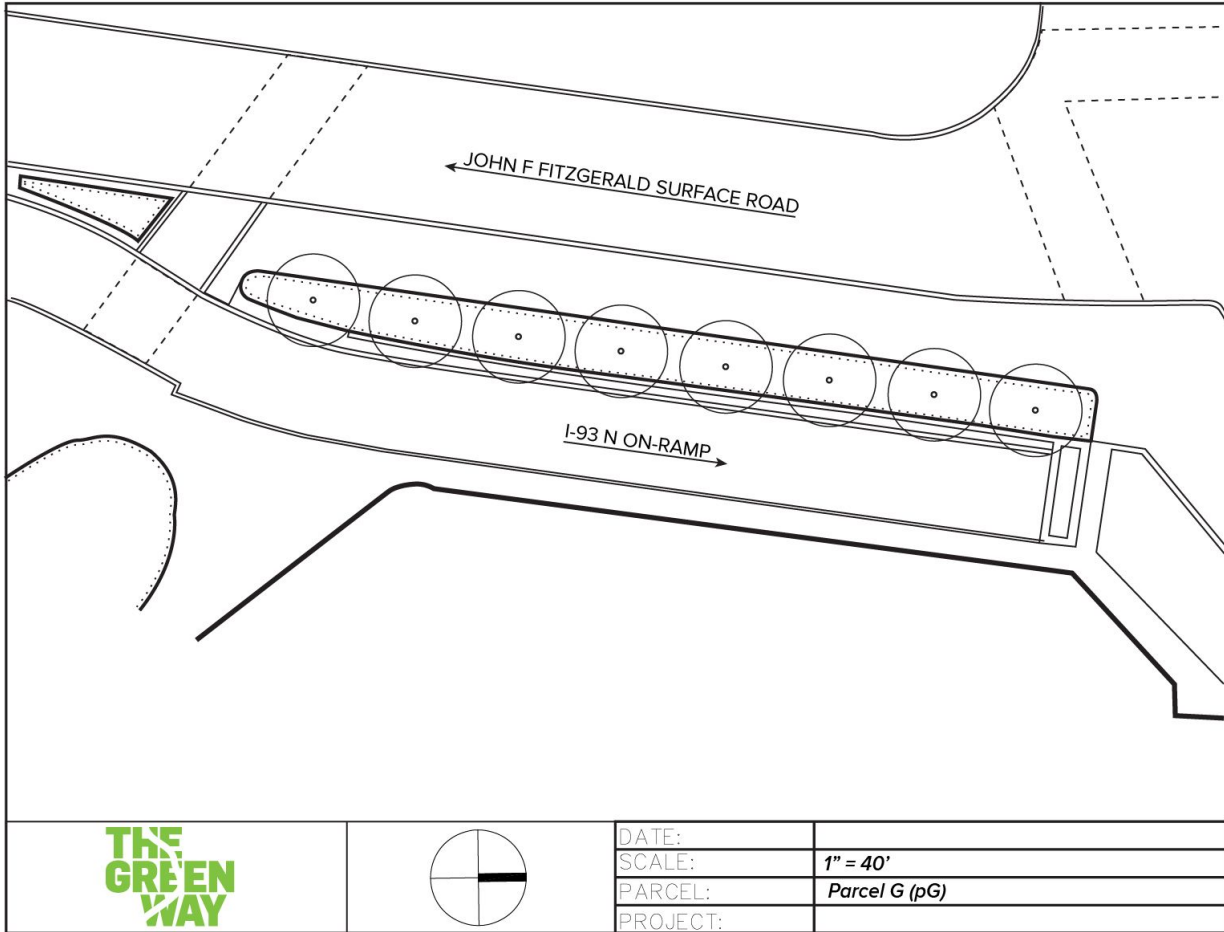



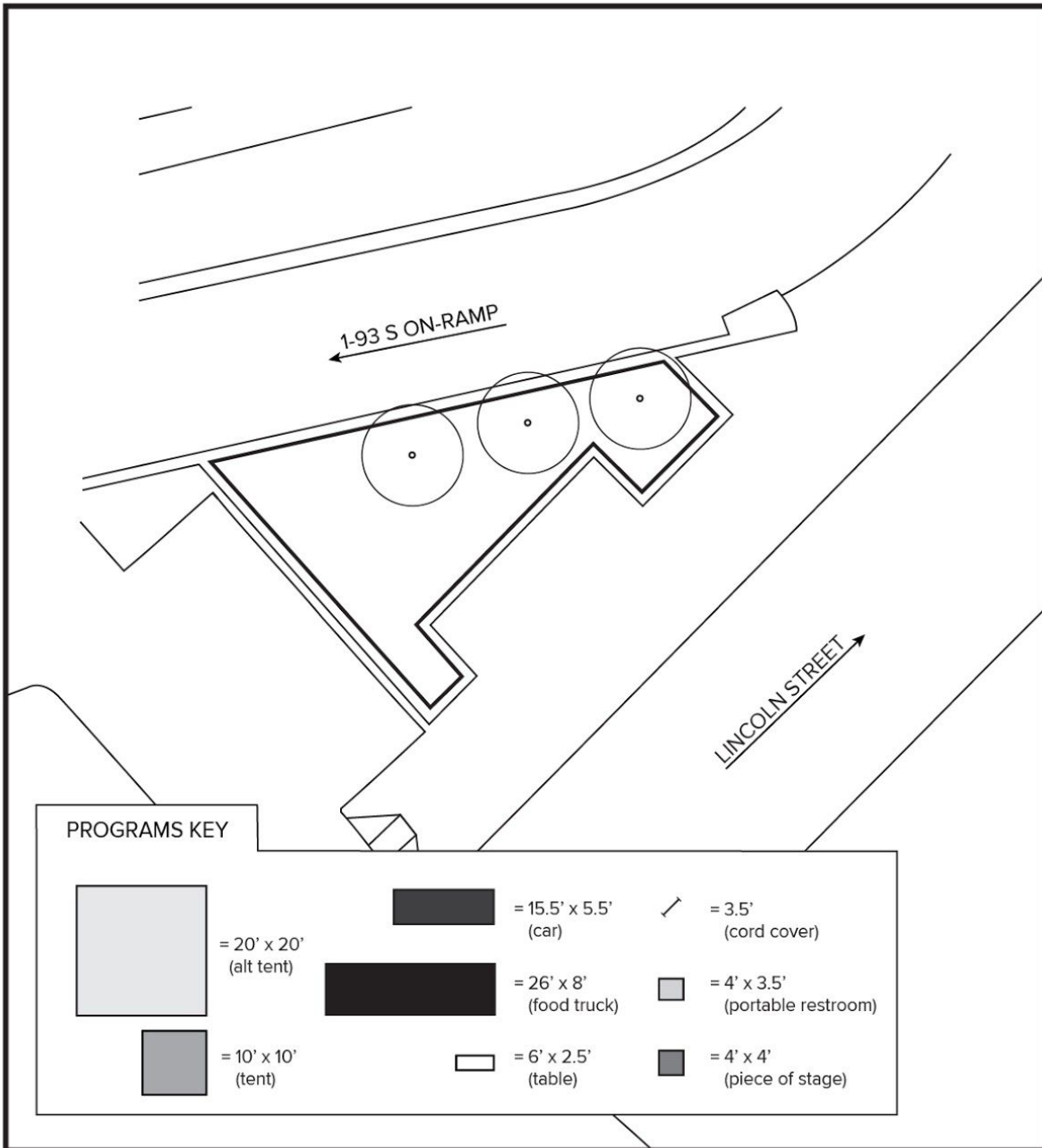

Parcel G: Summer Street and Essex Street

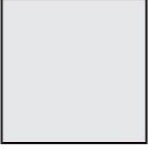

DATE:	
SCALE:	1" = 40'
PARCEL:	Parcel G (pG)
PROJECT:	

Parcel H: Lincoln Street and Tufts Street



PROGRAMS KEY					
	= 20' x 20' (alt tent)		= 15.5' x 5.5' (car)		= 3.5' (cord cover)
	= 10' x 10' (tent)		= 26' x 8' (food truck)		= 4' x 3.5' (portable restroom)
			= 6' x 2.5' (table)		= 4' x 4' (piece of stage)



DATE:	
SCALE:	1"= 20'
PARCEL:	Parcel H (pH)
PROJECT:	

Chinatown Park

Accessible by MBTA:

- Orange Line: Chinatown Station
- Red Line: South Station
- Silver Line: South Station
- Commuter Rail: South Station

Parcel 23: Essex Street and Beach Street

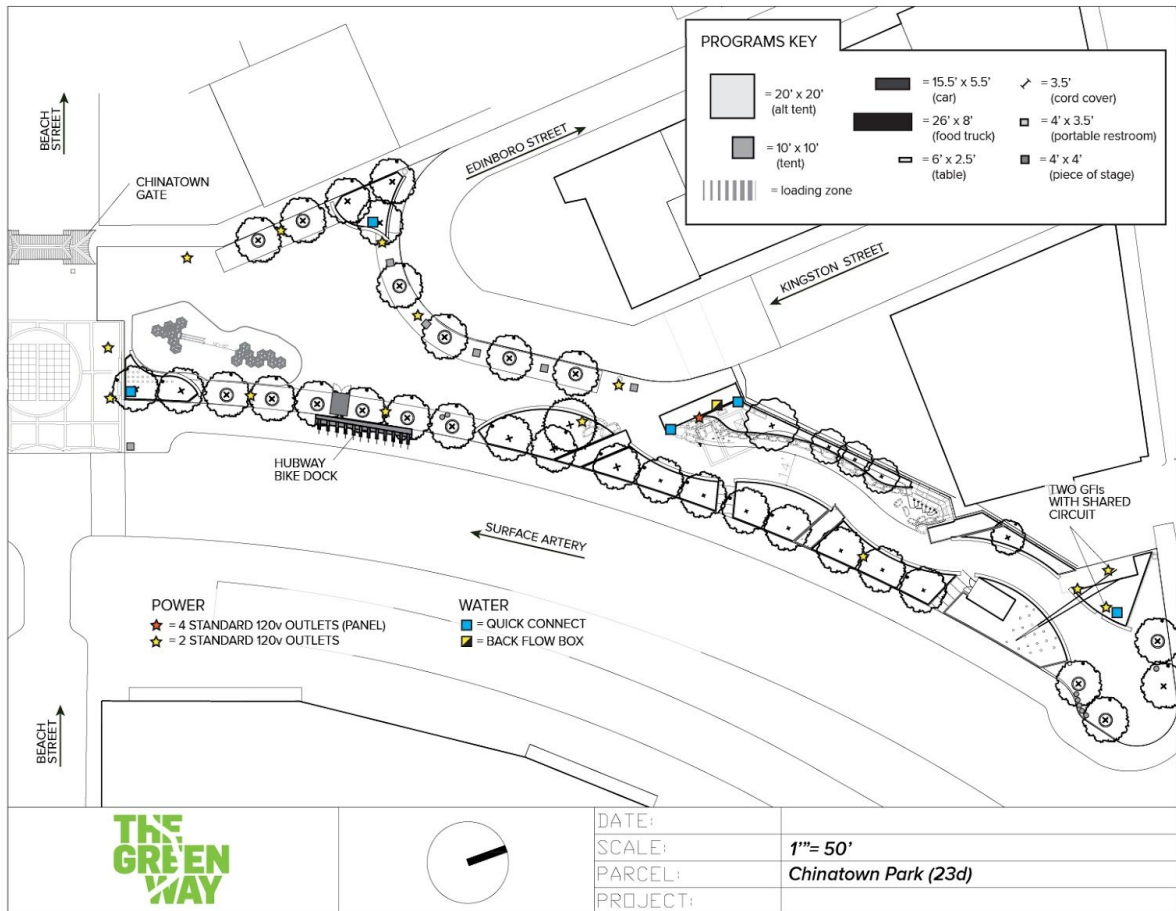

Parcel K/Mary Soo Hoo Park: Beach Street

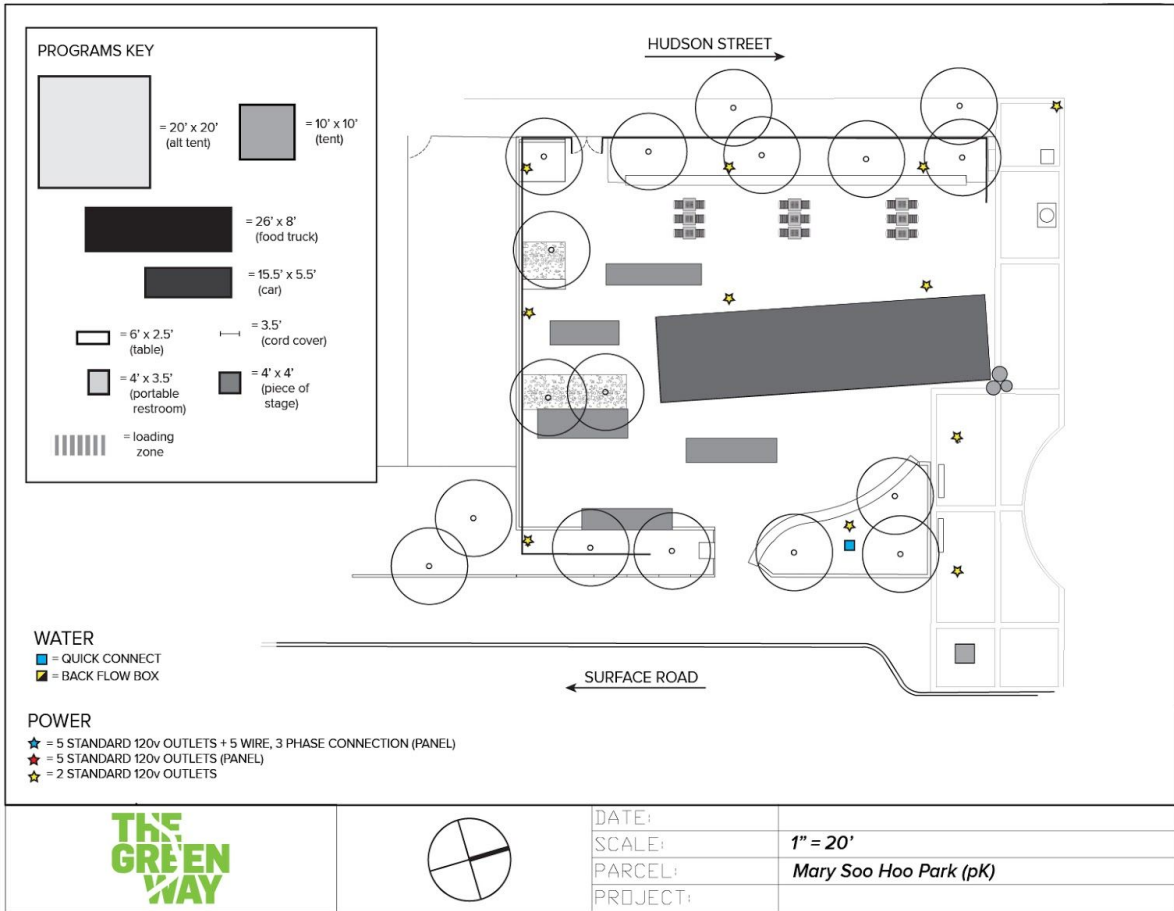

V. APPENDIX B: 2019 FEE STRUCTURE

Approved December 2018

- 1) **Non-Refundable Application Fee** – paid at time of event proposal submission to the Conservancy
 - a. Discounted fee for non-profit organizations: \$25
 - b. Fee for for-profit organizations: \$100Applications not submitted at least 30 days in advance of the proposed event date will be subject to an additional fee: \$50
- 2) **Furniture Moving** – The Greenway has hundreds of moveable tables, chairs and umbrellas in in the park. Should furniture need to be relocated, a fee will be charged based on the labor required: \$300 - \$800
- 3) **Programs staff support** – Should Conservancy programs staff be required either after normal business hours or on weekends, an hourly fee will apply: \$50/hour for non-profit organizations, \$100/hour for for-profit organizations
- 4) **Commercial and promotional activities** - Should an organizer or vendor wish to offer product samples or promote a product, service, or organization, a fee will be charged. The fee will vary based on duration, location, footprint, and nature of event.
 - a. **Sampling and Promotion** – Proposals for giveaways/promotions will be assessed to assure general public enjoyment of the park. Certain set-ups, footprints, and locations may not be possible. Fees will be assessed to assure that there is benefit to The Greenway: fees begin at \$375/hour for Dewey Square Park, \$325/hour for Rowes Wharf Plaza, \$275/hour for other Wharf District and North End Parks and \$150/hour for other locations.
 - b. **Markets** – The Greenway hosts park-appropriate commercial markets, such as farmers’ markets or artisans’ markets. Fees will be based on a revenue-share: 20-25% for-profits organizers, 5-15% non-profit organizers
 - c. **Other events including commerce** – For events with a money-making component for the organizer, a fee will be charged so that there is also a financial benefit to The Greenway. Fees can be structured as an upfront flat amount or as a revenue share, depending on the nature of the event.
- 5) **Deposits for damage and cleaning** – If a program or event 1) has an expected attendance of more than 1,000 participants, 2) is recurring or 3) proposes to use lawn areas on The Greenway, the Conservancy reserves the right to require a deposit in advance of the event. Lawn replacement and hardscape cleaning fees are on a per-square foot basis, and deposits will be based on the size of the event and the footprint of lawn or hardscape used. Lawn replacement rate: \$10 per square foot.

All park grounds must be protected from damage during load-in, load-out, and throughout your event. We will work with you to devise an appropriate protection plan. Event organizers are required to leave the park in as good condition as when they began load-in. If trash, debris or additional clean-up is required, the Conservancy may also charge an hourly rate for clean-up in excess of the deposit: \$300/hour.

A 50% deposit of the total estimated costs is required three weeks in advance of the event. Final payments are due no later than the start of set-up for the event or program on The Greenway.

Exhibit D: Skate Stop Types

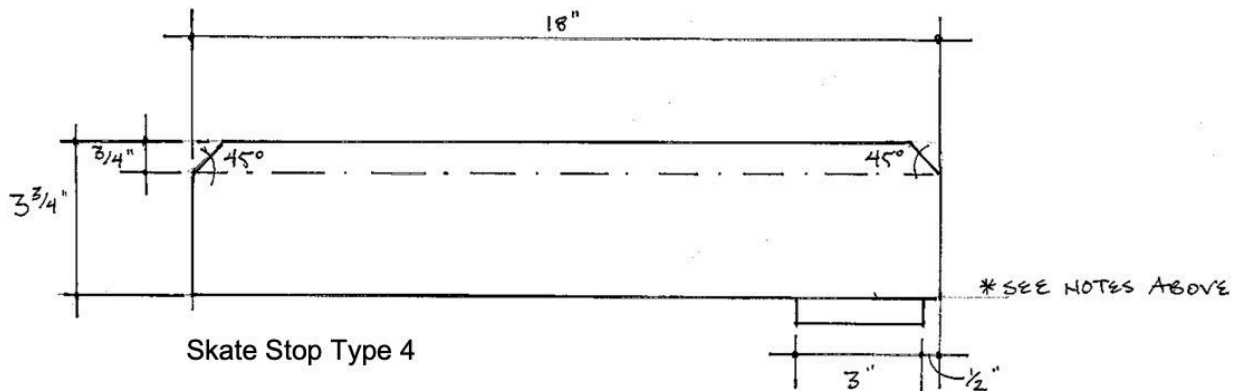
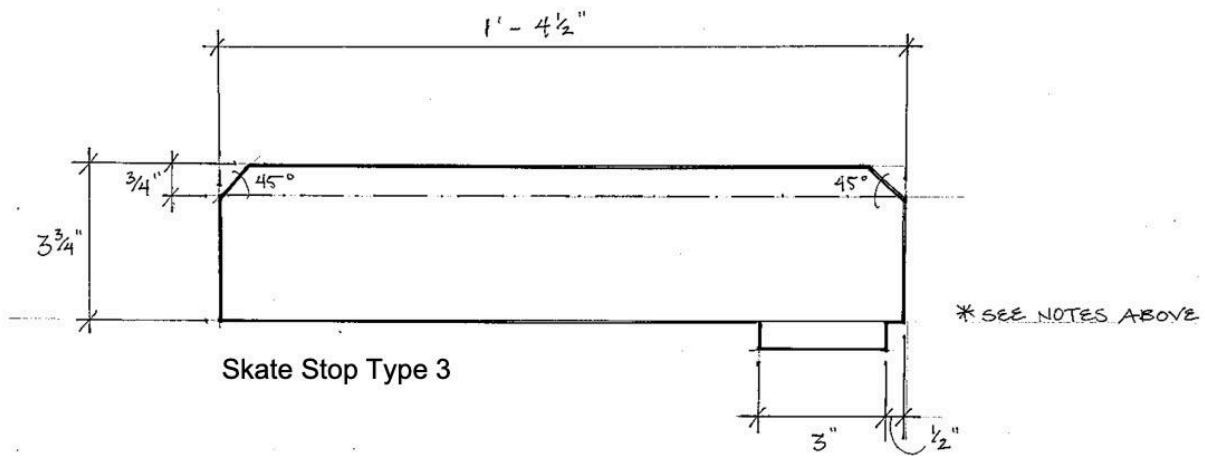
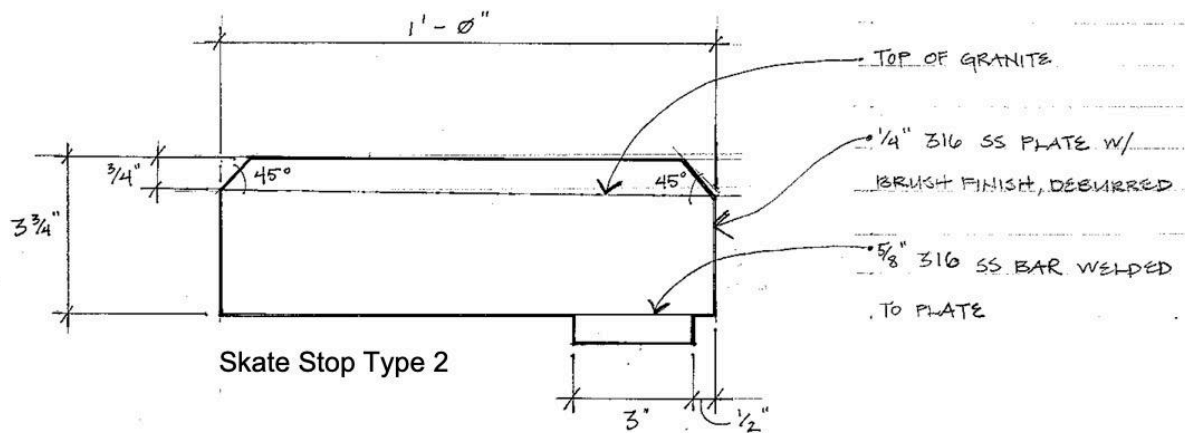
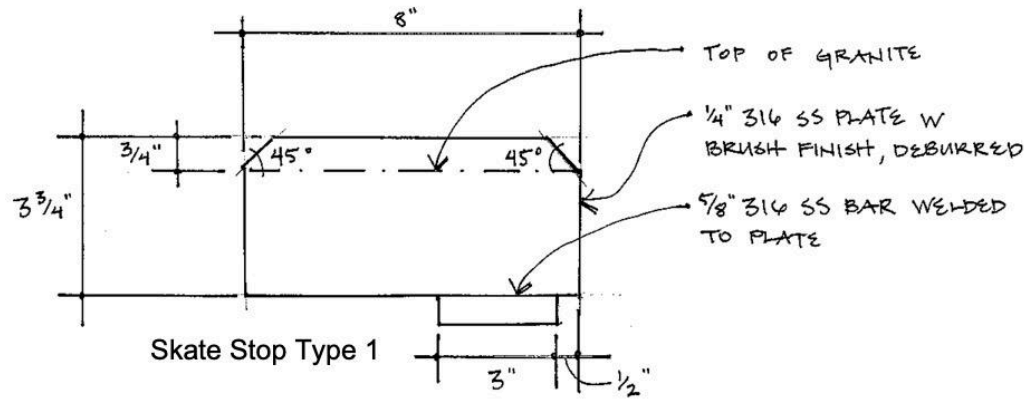

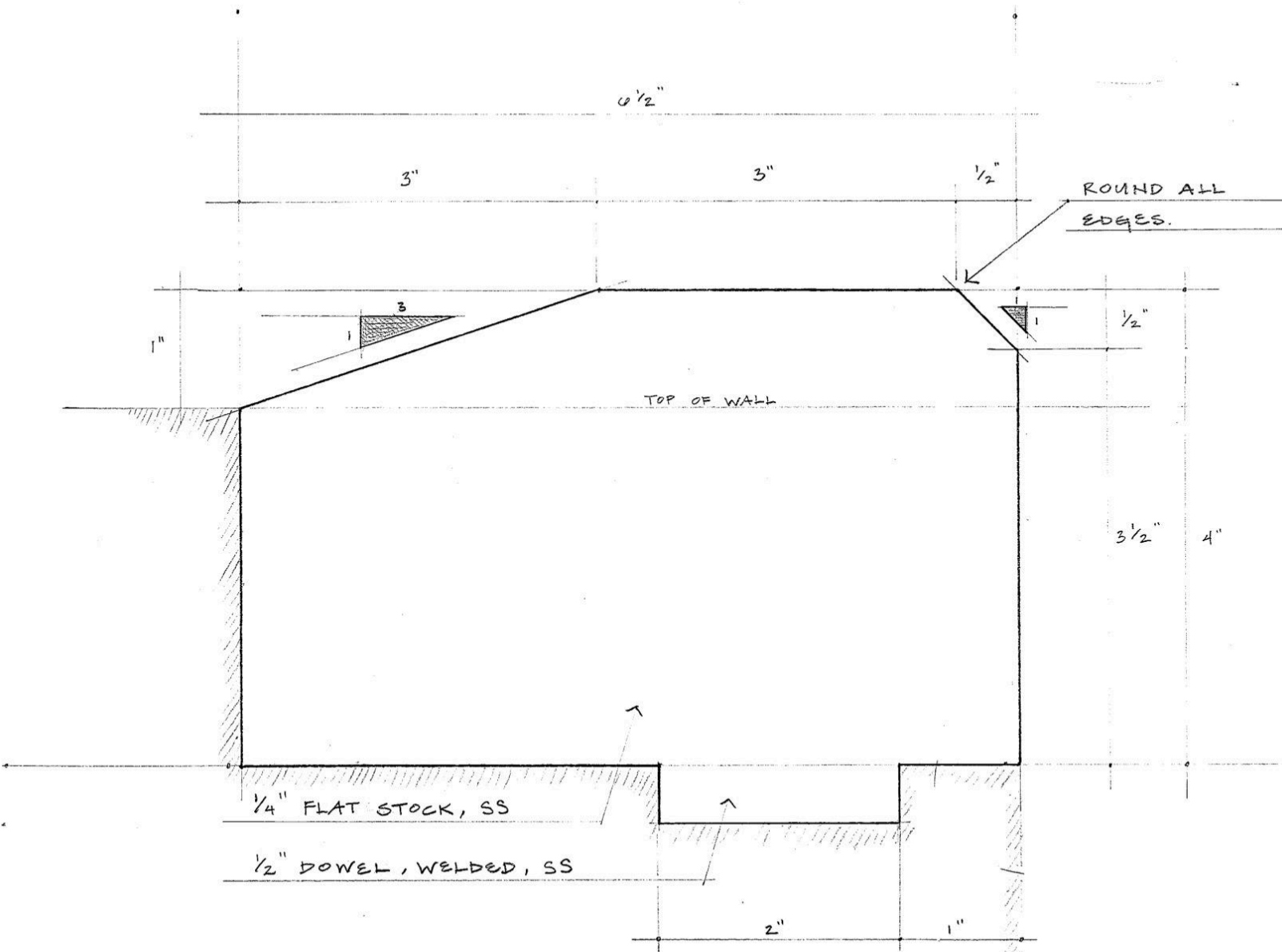

Skate Stop Type 5

DW Dots

Detectable Warning Specifications, Diagrams, Warranty & Instillation Guide

Contact:
Chris Hyams
619-582-9600

chris@dwdots.com

DW Dots INC.
1345 Horsemill Road
El Cajon, CA. 92021

Please visit our website:
www.dwdots.com

Patent # 7,249,911

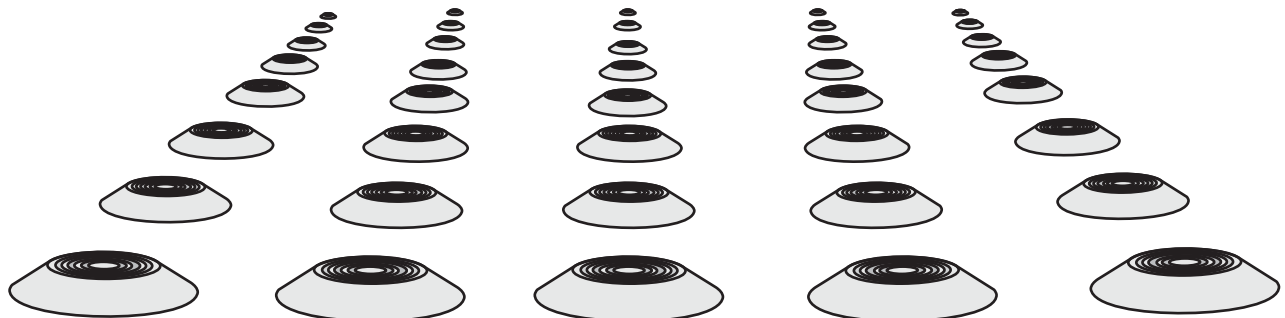

TABLE OF CONTENTS

INTRODUCTION

Company information-----	page 1
Table of contents-----	page 2
Product benefits -----	page 3

TRUNCATED DOME

DW Dots diagram-----	page 4
DW Dots material spec -----	page 5,6
DW Dots peg extender -----	page 7
Spacing patterns -----	page 8

INFORMATION AND INSTRUCTIONS

Product information-----	pages 9-13
Product installation-----	pages 14-16

PRODUCT BENEFITS

Detectable warning surfaces are to be maintained for life. Why install a product that might last 5 years? Current requirements are a 5 year warrantee, for foot traffic and natural exposure. When we all know that other elements are to blame, like vehicles, heavy equipment and regular maintenance, pressure washing and cleaning.

The most common walking surface for century's has been stone or concrete, because they can last for century's. Why not use the most common and the longest lasting product for a detectable warning field. Use colored concrete, stone or paver stones for your contrasting color, then use solid stainless steel DW Dots for the most durable detectable warning surface available.

No need to hire a specialty trade or subcontractor for installation, use your own crews to complete the work. Install DW Dots in the desired stone prior to on-site installation or after.

DW Dots diagram

Concentric circles tread

Top

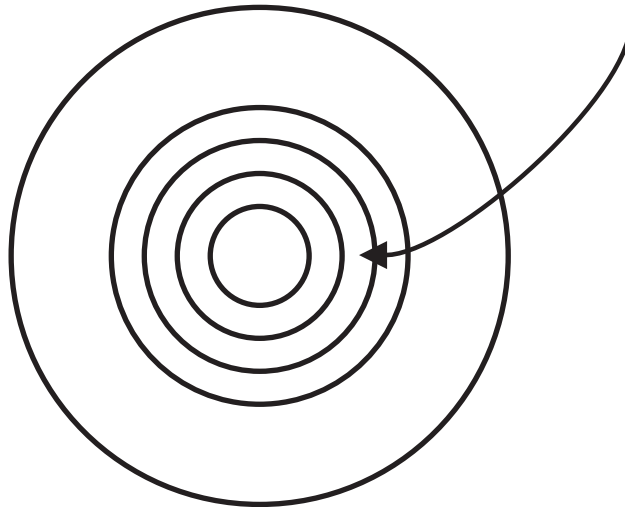

Depth of tread

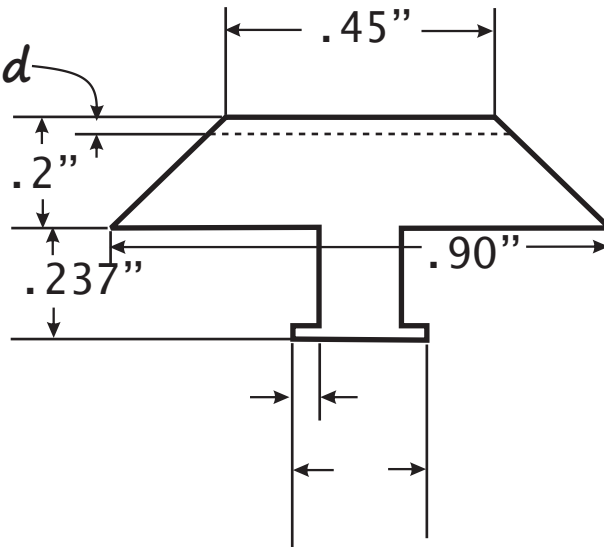

Side

DW Dots SP

made from 303,316, brass & other alloys

Material specifications

303 Stainless Steel Bar

Stainless Steel

T303



Description

Alloy 303 is a non-magnetic, austenitic stainless steel that is not hardenable by heat treatment. It is the free machining modification of the basic 18% chromium / 8% nickel stainless steel. Alloy 303 was specially designed to exhibit improved machinability while maintaining good mechanical and corrosion resistant properties. Due to the presence of sulfur in the steel composition, Alloy 303 is the most readily machineable austenitic stainless steel; however, the sulfur addition does lower Alloy 303's corrosion resistance to below that of Alloy 304. Like other austenitic grades, Alloy 303 demonstrates excellent toughness, although the sulfur does reduce this a little as well.

Alloy 303 is frequently used in applications that require parts to be heavily machined. Some examples include:

Nuts and bolts
Aircraft fittings
Gears
Screws
Shafts
Electrical switchgear components
Bushings

Chemical Composition

-  Chrome: 17.0 - 19.0
-  Nickel: 8.0 - 10.0
-  Carbon: .15 max.
-  Manganese: 2.00 max.
-  Silicon: 1.00 max.
-  Molybdenum: .60 max.
-  Sulfur: .15 min.

Material specifications







316 Stainless Steel Bar

UNS S31600/S31603 (Grade 316/316L Dual Certified)

316 stainless steel bar, also known as UNS S31600 and Grade 316, is an austenitic stainless steel whose major alloying elements include chromium, nickel and molybdenum. The addition of molybdenum (not found in Stainless Steel 304) is the component which gives Stainless Steel 316 increased resistance in highly corrosive surroundings such as salt water or chloride environments. Stainless Steel 316 offers better creep resistance at higher temperatures and greater strength than Stainless Steel 304. In the annealed state, Stainless Steel 316 is non-magnetic but can become slightly magnetic if extensively cold worked, further annealing would be necessary to correct this. Stainless Steel 316 cannot be hardened using thermal treatment. However, by cold working Stainless Steel 316, hardness and strength can be significantly increased.

UNS S31600/S31603 commonly known as Stainless Steel 316/316L Dual Certified is the low carbon content version of Stainless Steel 316. Stainless Steel 316/316L Dual Certified is used in heavy-gage welded products (over approximately 6mm). One advantage over Stainless Steel 316 is that it is more resistant to carbide precipitation and can be used in the 797° F-1580° F range, which is more suitable for applications involving corrosion resistance.

Industries that use 316 and 316/316L Dual Certified include:

-  Architectural (in corrosive environments)
-  Chemical
-  Marine
-  Mining
-  Petroleum
-  Pharmaceutical
-  Pulp and Paper

Bar Specifications

Uns	Type	Ams	Astm	Federal	Characteristics
S31600/S31603			316/316L	DUAL CERTIFIED	5648
5653	A-276				
A-314					

A-479 QQ-S-763 316/316L Dual Certified is an extra low carbon version of 316, eliminating harmful carbide precipitation during welding. Also has superior resistance to intergranular corrosion after welding of stress relieving.

Chemistry Analysis

C	MN	P	S	SI	CR	NI	MO	CU	OTHER	M/NM
.03	1.25 - 2.		.04	.03	1.	16. - 18.	10. - 14.	2. - 3.		.75
	NM									

DW Dots Peg extenders

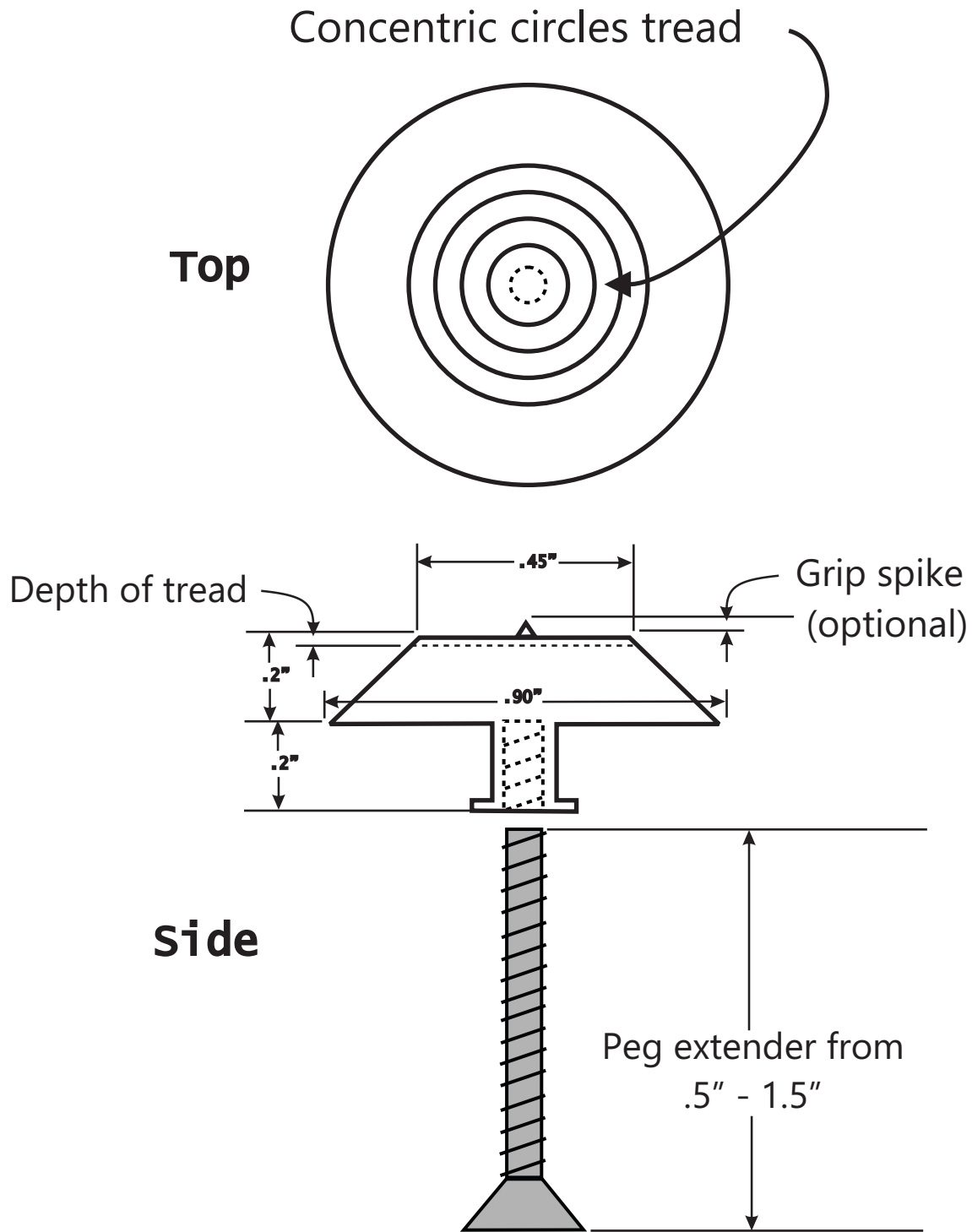

DW Dots Standard spacing

Square pattern
diagonal alignment

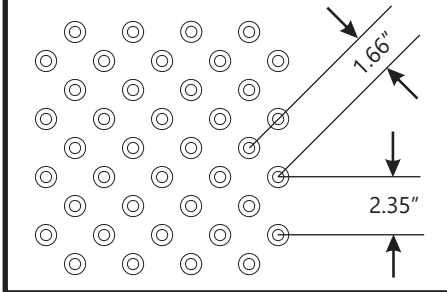

Square pattern
parallel alignment

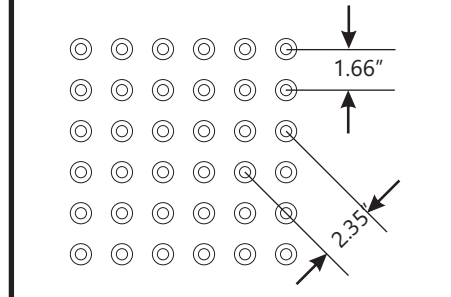

Triangular pattern

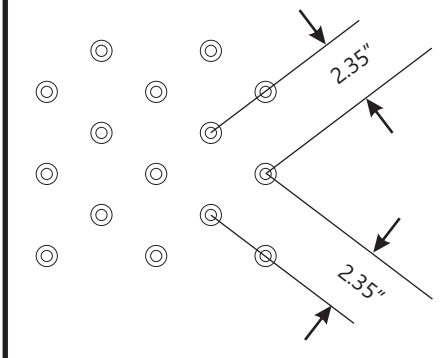

Square pattern
@ 2.35"

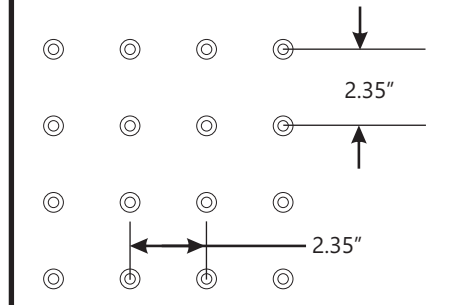

Square pattern
@ 2.00"

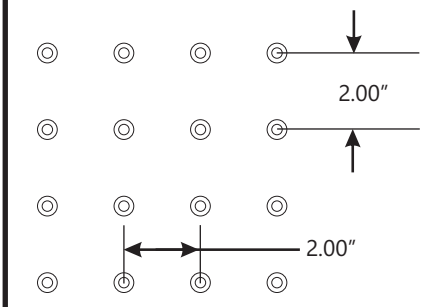

CUSTOM LAYOUT
AVAILABLE

DW Dots tactile warnings

Part 1 General

1. Related documents

- A. Drawings and general provisions of contract, including General and Special Conditions and Division 1 Specifications Section, apply to this Section.

2. DESCRIPTION

- A. This Section specifies furnishing and installing surface applied DW Dots where indicated, using an exterior grade tactile warning surface herein.

3. SUBMITTALS

- A. Product Data: Submit manufacturer's literature describing products, installation procedures and routine maintenance.
- B. Samples for Verification Purpose: Submit a minimum of (3) samples of a full size detectable/tactile warning tile of the kind proposed for use.
- C. Shop drawings are required for products specified showing fabrication details; tile surface profile; composite structural system; plans of tile placement including joints, and material to be used as well as outlining installation materials and procedures.

DW Dots tactile warnings

- D. Material Test Report: Submit test reports from qualified independent testing laboratories indicating that the materials proposed for use are in compliance with requirements and meet the properties indicated.
- E. Maintenance Instructions: Submit copies of manufacture's specified maintenance practices for each type of detectable/tactile warning surface and accessory as required.

4. QUALITY ASSURANCE

- A. Provide surface applied DW Dots as produced by a single manufacture with at least (1) year experience in manufacturing of DW Dots.
- B. Installer Qualifications: Engage an experienced installer who has successfully completed installations similar in material, design, and extent to that indicated for Project.
- C. Americans with Disability Act (ADA): Provide a tactile warning surfaces which comply with the detectable warnings on walking surfaces section of the Americans with Disabilities Act (Title III Regulations, 28 CFR Part 36 ADA STANDARDS FOR ACCESSIBLE DESIGN, Appendix A, Section 4.29.2 DETECTABLE WARNINGS ON WALKING SURFACES). California Code of Regulations (CCR) Title 24, part 2, Section 205 definition of "Detectable Warning" Section 1127B.5 for "Curb Ramps".

DW Dots tactile warnings

D. Dimension: The size of the truncated dome is a nominal height of .2" with a top diameter of .45" and base diameter of .9" spaced from center to center 1.66" to 2.35" inline or staggered. The top of the dome has concentric circles cut into the solid metal dome for an aggressive long lasting non-slip surface.

1. Abrasive wear of DW Dots when tested by BYK - Gardener tester ASTM D 2486-00 with reciprocating liner motion of 37+/- cycles per minute over a 10" travel. The abrasive median, a 40 grit Norton Metallite sand paper, to be fixed and leveled to a holder. The combined mass of sled, weight, wood block is to be 3.2 lbs. Average wear depth shall not exceed 0.030 after 1,000 abrasion cycles on the top surface of dome representing the average of three measurement locations per sample.
2. Slip resistance of DW Dots when tested by ASTM C 1028 no less than 0.80 for the wet/dry combined total.
3. Compression strength of DW Dots when tested by ASTM D 695-91 no less than 18,000 psi.
4. Tensile strength of tile/concrete with DW Dots by Direct Pull off Method ASTM C 153-04 tensile bond strength shall not be less than 165 psi.
5. Gardner impact to geometry "GE" of the standard when tested by ASTM D 5420-93 to have a mean failure energy expressed as a function specimen thickness of not less than 450 in. Ibf/in. A failure is noted if a hairline fracture is visible in the specimen.

DW Dots tactile warnings

6. Accelerated Aging and Freeze Thaw Test of DW Dots when tested to ASTM 1037-99 shall show no evidence of cracking, delimitation, warping, checking, blistering, color change, loosening of domes or other detrimental defects.
7. Salt and spray performance of DW Dots when tested to ASTM B117-03 not to show any deterioration or any other defects after 1000 hours of exposure.

5. DELIVERY, STORAGE HANDLING

- A. DW Dots products shall be suitably packed or created to prevent damage in shipment or handling.
- B. DW Dots products shall be stored in a dry location, inside and kept above 40 degrees F.
- C. Keep all products clean and free from any oils, dirt, wax, cleaning solutions, and construction debris.
- D. DW Dots products shall be delivered to location at building site for storage prior to installation.

6. SITE CONDITIONS

- A. Environmental Conditions and Protection: Maintain a minimum temperature of 50 degrees F and dry in the area to receive DW Dots for at least 24 hours prior to installation, during installation and for no less than 24 hours after installation.

DW Dots tactile warnings

- B. The use of water for work , cleaning or dust control, etc. Shall be contained and controlled and shall not be allowed to come in contact with the general public. All water and debris shall be disposed of in accordances with all Local, State and Fedral laws. All areas need to dry and moisture free 24 hrs before and after epoxy installation.
- D. Provide barricades to protect the general public and protect work area from start to finish.
- E. All new concrete materials that will need drilling and bonding, \ needs to cure for minimum of 28 days from pour, or reach required VOC count per adhesive Manufacturing guidelines.

7. GUARANTEE

- A. DW Dots Detectable/Tactile Warning Surface shall be guaranteed in writing for a period of five (5) years minimum from the date of final completion. The guarantee/warentee of supplied materials for breakage, deformation, fading, size and shape complies with ADA requirements.

8. MATERIALS

- A. Stainless steel parts are made from solid bars of certified 303, 316 & 316L (certificates upon request).
- B. Powerstick adhesive by Powers/Dewalt

DW Dots Installation Guide

Mark drill bit, and install stopper for fastest and precis installation.

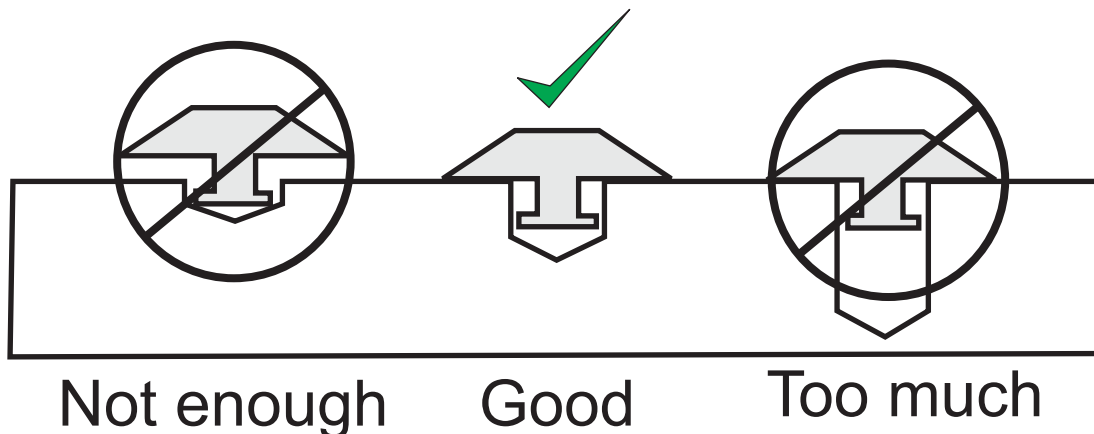
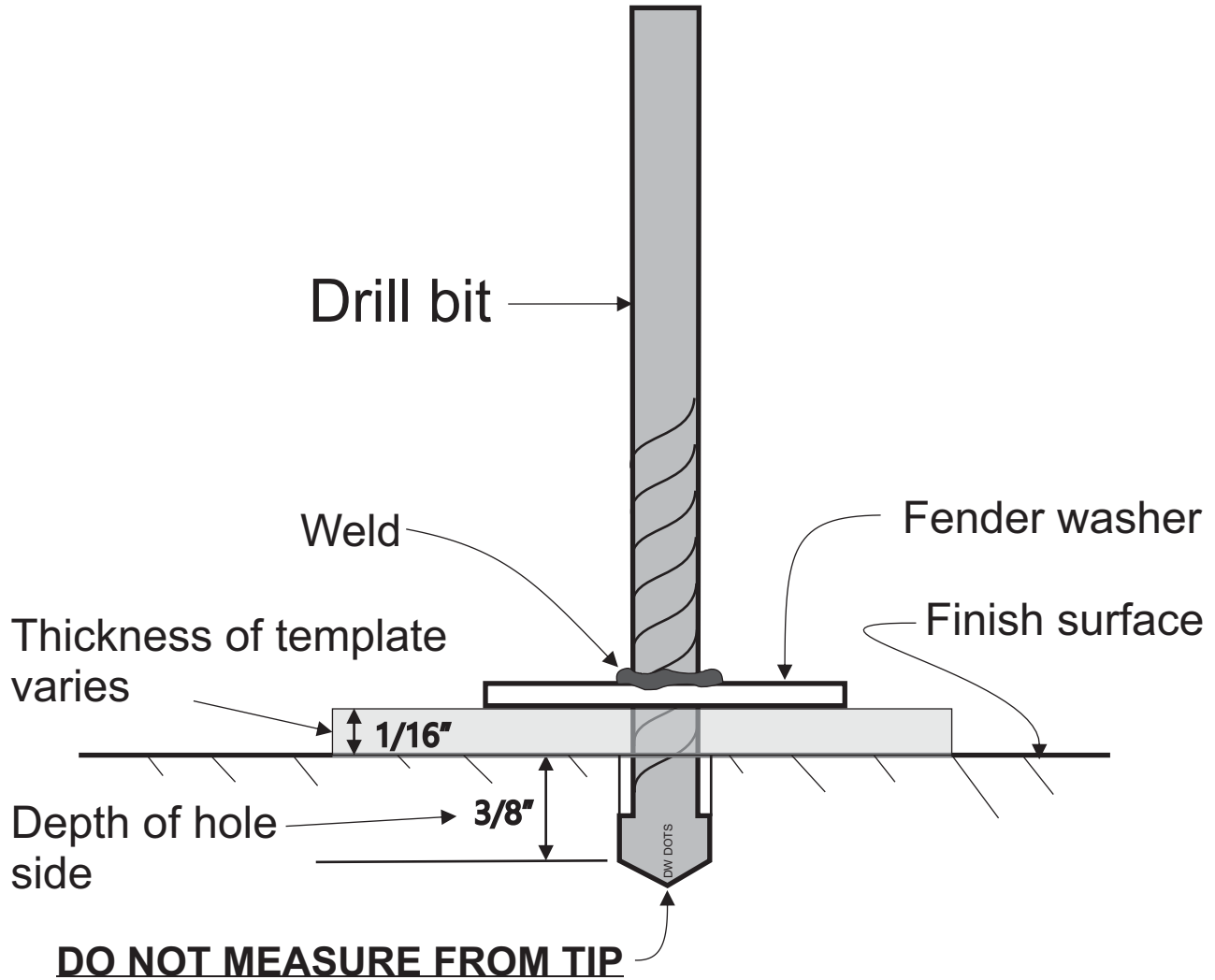

DW Dots Installation Guide

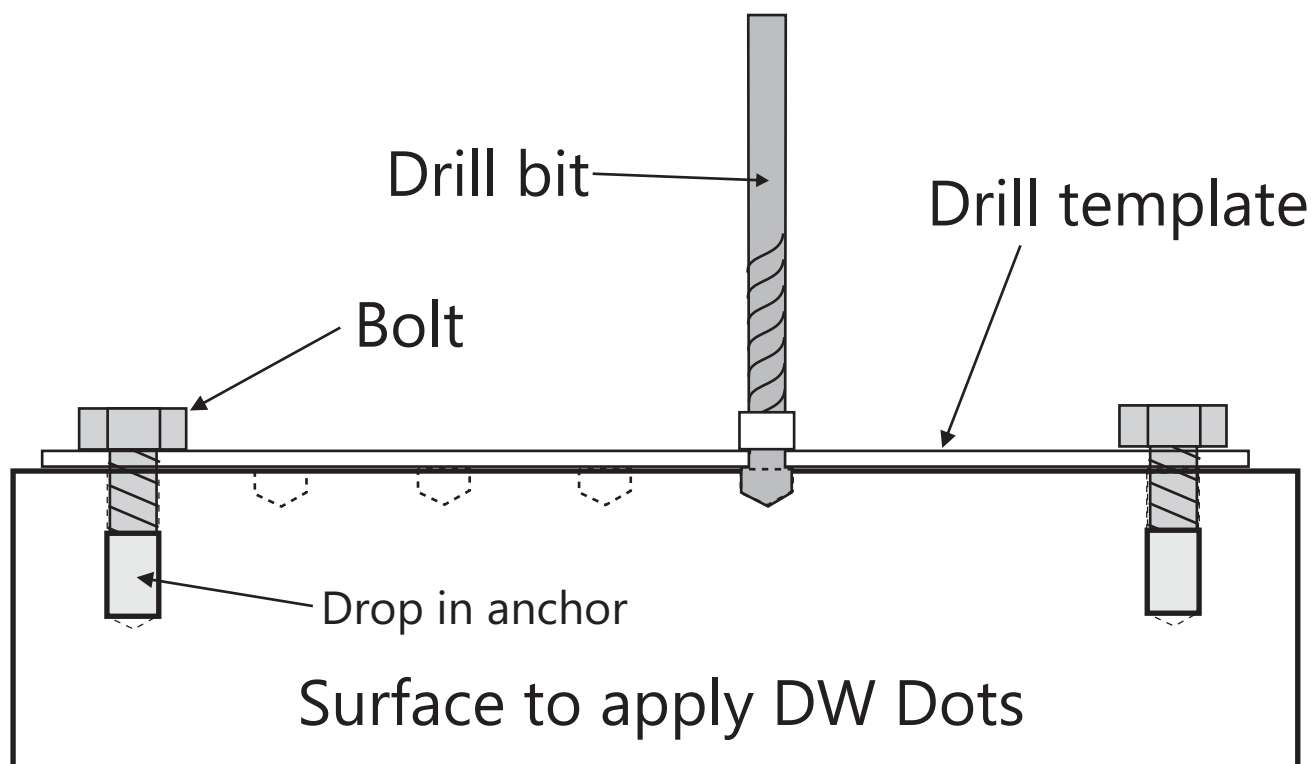

Lay drill template down on surface. Check alignment of holes, they look best when holes are centered in field of work. Stay within code, check plans for exact locations.

Secure template from moving and drill first hole in corner use a drop in anchor to fasten template to work area. Make sure the top of anchor is low enough not to interfere with dome. Fasten anchor with appropriate size bolt and repeat on the opposite corner of template. Drill out remaining holes in template as needed. Move template through field of work using as needed overlapping holes

DW Dots Installation Guide

Remove loose debris and follow adhesive manufacture instructions for cleaning and anchoring domes.

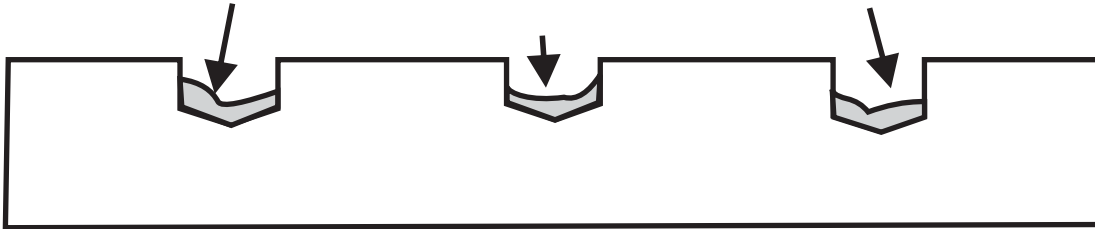

Squeeze adhesive in holes through the mixing tip provide. **DO NOT OVER FILL** the holes. Check right away with a dome to determine how much adhesive to put in each hole.

